



**8 3 3**

COMPACT FIELD MIXER-RECORDER

**SOUND**  **DEVICES**

## Legal Notices

Product specifications and features are subject to change without prior notification.

Copyright© 2019 Sound Devices, LLC. All rights reserved. This product is subject to the terms and conditions of a software license agreement provided with the product, and may be used in accordance with the license agreement. This document is protected under copyright law. An authorized licensee of this product may reproduce this publication for the licensee's own personal use. This document may not be reproduced or distributed, in whole or in part, for commercial purposes, such as selling copies or providing educational services or support. This document is supplied as a technical guide. Special care has been taken in preparing the information for publication; however, since product specifications are subject to change, this document might contain omissions and technical or typographical inaccuracies. Sound Devices, LLC does not accept responsibility for any losses due to the user of this guide.

## Trademarks

The "wave" logo is a registered trademarks; Wave Agent ia a trademark of Sound Devices, LLC. Windows and Microsoft Excel are registered trademarks of Microsoft Corporation in the U.S. and other countries. All other trademarks herein are the property of their respective owners.



### WEEE Statement

If you wish to discard a Sound Devices product in Europe, contact Sound Devices (Germany) for further information.



*Warning! This device can drive headphones to potentially dangerous levels. Do not listen at high volume levels for long periods.*

Read and fully understand this manual before operation.

## 833 User Guide | Rev 1 | 09/12/19

This document is distributed by Sound Devices, LLC in online electronic (PDF) format only. Published in the USA.

**This table provides the revision history and cross-reference links to "what's new" in this guide.**

REV #	DATE	VERSION	DESCRIPTION
1-A	09/19	A	v2.10 Initial Release

## Included Accessories

PART NUMBER	DESCRIPTION
2479.000	Cordset 6' AC cable
9623.001	XL-WPTA4 power supply TA4 Connector
9244.003	LCD cover
9772.000	Antenna, SMA connector
5529.000	Promo Sticker (white)
5537.000	Promo sticker (black)
1312.000	Dot: Red, Yellow, Blue,Green, Purple, White (8 each)

**SOUND**  **DEVICES**

Post Office Box 576  
E7556 State Rd. 23 and 33  
Reedsburg, Wisconsin 53959 USA  
[www.sounddevices.com](http://www.sounddevices.com)

+1 608.524.0625 main  
+1 608.524.0655 fax  
800.505.0625 toll free  
[support@sounddevices.com](mailto:support@sounddevices.com)

## Manual Conventions

SYMBOL	DESCRIPTION
>	This symbol is used to show the order in which you select menu commands and sub-options, such as: Main Menu > Outputs indicates you press the Menu button for the Main Menu, then scroll to and select Outputs by pushing the Encoder.
[ ]	This symbol is used to convey selectable menu items.
*	This symbol is used to convey factory default settings.
+	A plus sign is used to show button or keystroke combinations. For instance, Ctrl+V means to hold the Control key down and press the V key simultaneously. This also applies to other controls, such as switches and encoders. For instance, MIC+HP turn means to slide and hold the MIC/TONE switch left while turning the Headphone (HP) encoder. METERS+SELECT means to hold the METERS button down as you press the SELECT encoder.
*	A <i>note</i> provides recommendations and important related information. The text for notes appears italicized.
*	A cautionary warning about a specific action that could cause harm to you, the device, or cause you to lose data. Follow the guidelines in this document or on the unit itself when handling electrical equipment. The text for cautionary notes also appears italicized and bold in a different color.

# Welcome to the 833

## **FULLY ROUTABLE. ULTRA-PORTABLE.**

The 833 is the professional's tool for mobile and small productions. Like the popular Sound Devices 633, the 833 is small, lightweight, and compact. A tactile interface with dedicated faders, trim knobs, and PFL switches makes this mixer-recorder ideal for run-and-gun bag use.

The 833 has 6 mic/line preamplifiers, 8 channels, 12 tracks, 6 analog outputs, and ultra-accurate timecode. Many features have carried over from the premium Sound Devices' Scorpio, such as Sound Devices' new preamplifier design, 2 SD card slots, dual L-Mount battery charging and powering, and an internal 256 GB SSD.

Additionally, the 833 shares the same processing architecture and multiple FPGAs as the Scorpio. This enables the 833 to be fully routable, and any physical input can be routed to any track. The 833 features both digital and analog inputs and outputs, and has multiple powering options, so it will fit effortlessly into your existing kit.

A built-in three band EQ may be set to either pre- or post-fade for each channel to tackle any problems directly on-set. Enable Dugan Automixing to automatically attenuate unused microphones in multi-microphone applications. Up to 8 channels can be automixed at a time, and two separate groups can be mixed simultaneously.

Dedicated coms and slate allows for professional bi-directional communication with other crew members. Send customized mixes to the camera or crew with multiple mix buses. With the ability to record to three media simultaneously, you can turn over SD cards to production at the end of the day while keeping a backup on the internal 256 GB SSD.

The 833 may be controlled via the companion Android app, SD-Remote, which features transport controls, metering, and sound reports. For an instant mobile workstation, choose from one of several supported USB control surfaces for remote fader and transport control.

## **We are honored to be part of your kit.**

Sincerely,  
Sound Devices

# Table of Contents

<b>PANEL VIEWS</b>	<b>3</b>
<b>FRONT PANEL</b>	<b>3</b>
<b>LEFT SIDE PANEL</b>	<b>4</b>
<b>RIGHT SIDE PANEL</b>	<b>5</b>
<b>REAR PANEL</b>	<b>6</b>
<b>TOP PANEL</b>	<b>6</b>
<b>HOME SCREEN</b>	<b>7</b>
<b>CHANNEL SCREEN</b>	<b>8</b>
<b>MENUS</b>	<b>12</b>
<b>POWER MENU</b>	<b>13</b>
<b>CHANNEL SETUP</b>	<b>13</b>
<b>BUS MENU</b>	<b>14</b>
<b>OUTPUT MENU</b>	<b>15</b>
<b>AUTOMIXER</b>	<b>17</b>
<b>METERS</b>	<b>18</b>
<b>TIMECODE</b>	<b>18</b>
<b>RECORD/PLAY</b>	<b>20</b>
<b>FILES</b>	<b>21</b>
<b>SLATE/COMS/RETURNS</b>	<b>22</b>
<b>SYSTEM</b>	<b>25</b>
<b>CONTROLLERS</b>	<b>26</b>
<b>TOGGLE SWITCH SHORTCUTS</b>	<b>29</b>
<b>FRONT PANEL SHORTCUTS</b>	<b>29</b>
<b>USB KEYBOARD</b>	<b>32</b>
<b>QUICK SETUP</b>	<b>33</b>
<b>SD REMOTE</b>	<b>35</b>
<b>SPECIFICATIONS</b>	<b>38</b>
<b>GLOSSARY</b>	<b>42</b>

# Panel Views

## FRONT PANEL

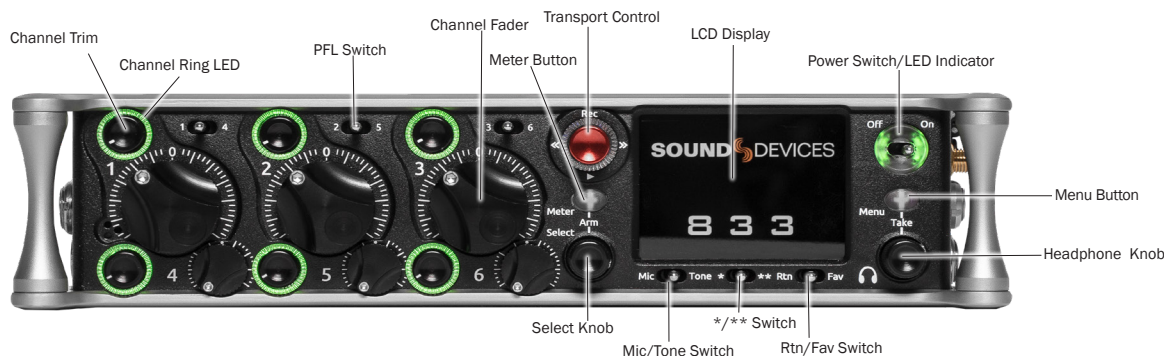

**CHANNEL TRIM** Turns the channel on/off and sets the input gain for the channel. To conserve power, turn off unused channels by rotating channel trim fully counter-clockwise.

**CHANNEL LED RING** Provides visual indication of channel signal condition, solo and mute, and whether a channel is on or off.

**CHANNEL FADER** Controls the audio level of the channel as it contributes to the L/R mix and any destinations selected in routing as "Post".

**PFL SWITCH** Pre/Post Fade Listen selects the channel in the headphones for Pre/Post Fade Listen while simultaneously entering the channel screen. Also used for accessing virtual keyboard for channel naming and various shortcuts.

**TRANSPORT CONTROLS** A joystick (with its illuminated LED ring) on the front panel is used to perform various transport control functions. (see table below). The ring LED will flash orange post roll while writing to media.

Function	Action
Record	Push up the Transport control to begin recording a new file. The LED ring illuminates red while recording is underway.
Stop	Press in the Transport control to stop recording or playback. While in standby, press and hold to display next take name.
Play	Push down on the Transport control to begin playback of the last file recorded or file currently loaded. While in playback, push down again to pause playback. The LED ring as well as the active file in the display will flash to indicate that Pause is active. Push down again to continue playback.
Rewind / Load Previous Take	While in standby, push left to load the previous take. While in playback, push and hold left to rewind. When the 833 is playing back or paused, moving the joystick to the left (<<) rewinds at 2x speed, then after holding for 5 seconds, it increases to 16x speed.
Fast Forward / Load Next Take	While in standby, push right to load the next take. While in playback, push and hold right to rewind. When the 833 is playing back or paused, moving the joystick to the right (>>) fast forwards at 2x speed, then after holding for 5 seconds, it increases to 16x speed.
Scrub	While playing or paused, press the headphone knob to enter Scrub mode. Then rotate clockwise for fast forward or counter-clockwise for rewind speeds of 0x, 1/8x, 1/4x, 1/2x, 1x, 2x, 4x, 8x, and 16x. The audio may be heard in scrub mode up to 2x speed.

**METER BUTTON** Push to view and select various metering presets. Used with Select knob. Push again to return to Home Screen.

### SELECT KNOB

1. Push to view Outputs list, rotate and push to Select Output Screen. Push Meter Button to return to Home Screen.
2. Rotate to select track in display, push both Meter and Select at the same time to arm/disarm track. While holding the Meter Button, multiple consecutive tracks may be armed by holding in the Select knob and rotating.
3. Use with Meter Button to scroll through meter views then push to Select.
4. Push with Channel Select switches 1-6 for shortcut to Bus 1-4, L,R routing.
5. Menu navigation and push to Select.

**MIC/TONE SWITCH** Toggle slate mic and tone generator. Soft button for menus.

**\*/\*\* SWITCH** User-programmable shortcut toggles.

**POWER SWITCH/LED INDICATOR** Turns the power on and off. Switch LED ring indicates the following:

1. Power condition: green = good, orange = warning, red = shutdown imminent.
2. Flashing blue = power is off and holding timecode.
3. Continuous blue = booting up.
4. Flashing yellow = unit is off and charging L-mount batteries.
5. Continuous yellow = unit is off and both L-mount batteries are fully charged.

**MENU BUTTON** Push to enter the Main menu. Also used to exit menus.

### HEADPHONE KNOB

1. Rotate to control headphone volume.
2. Press to open headphone preset menu and select.
3. Menu navigation and push to select.
4. Press Menu and HP Encoder to enter Take List.
5. Press > 0.5s during playback to enter audio scrub mode.

**LEFT SIDE PANEL**

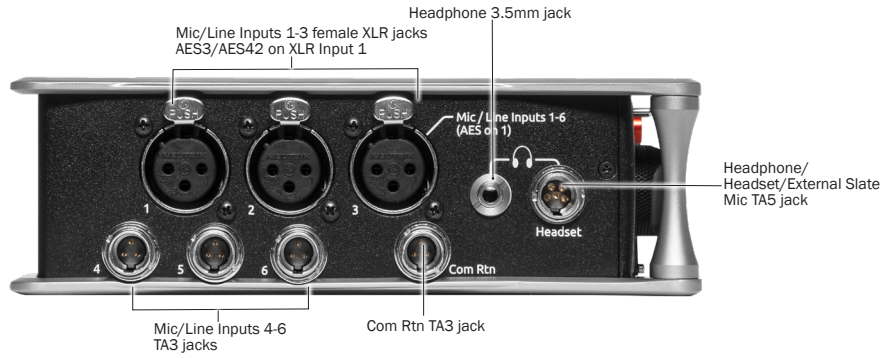

**INPUTS 1-3 FEMALE XLR JACKS** Active-balanced analog microphone or line-level inputs. Input 1 can also accept AES3 or AES42 signal. [pin-1 = ground, pin-2 = hot (+), and pin-3 = cold (-)].

**MIC/LINE INPUTS 4-6 TA3 JACKS** Active-balanced analog microphone or line-level inputs. [pin-1 = ground, pin-2 = hot (+), pin 3 = cold (-)].

**COM RTN TA3 JACK** Balanced connection for Com Return 1 audio input. [pin-1 = Ground, pin-2 = hot (+), pin-3 = cold (-)].

**HEADPHONE 3.5 MM JACK** Unbalanced output and TRS headphone output. *Warning! This output can drive headphones to potentially dangerous levels. Routing determined in the Outputs menu.* [Sleeve = ground, tip = left, ring = right].

**HEADPHONE/HEADSET TA5 JACK** Headphone and slate microphone connections [pin-1 = HP right, pin-2 = HP left, pin-3 = ground, pin-4 = mic -, pin-5 = mic+].

**RIGHT SIDE PANEL**

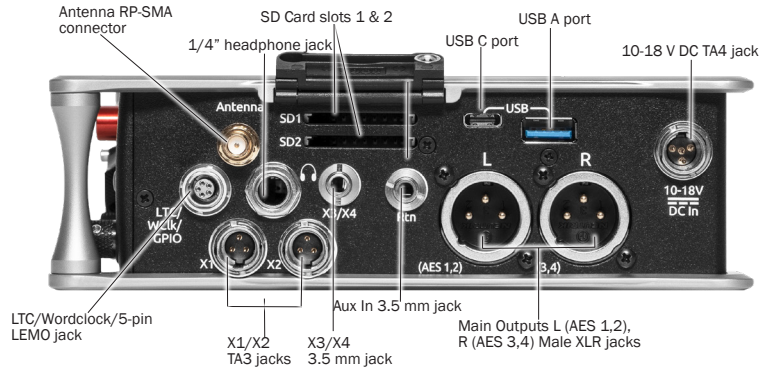

**ANTENNA RP-SMA-MALE CONNECTOR** Connects to included external antenna for Bluetooth LE.

**SD 1 AND 2 CARD SLOTS** Insert SD card media for recording. Insert label side down.

**USB C PORT**  
File transfer.

**USB A PORT**

1. USB keyboard.
2. USB to SD-Remote Android app.
3. USB to approved 3rd party fader controllers.
4. Supports USB hubs.

**10-18V DC TA4 JACK** Accepts DC voltages from 10–18 V for powering. [pin-1- GND, pin-2- Smart Battery DATA, pin-3- Smart Battery CLOCK, pin-4- +10-18 VDC].

**LTC/WORDCLOCK/5-PIN LEMO JACK** Timecode I/O, Wordclock. [pin-1- GND, pin-2- LTC or WORDCLOCK IN, pin-5- LTC or WORDCLOCK OUT (Pins 2 and 5 are software selectable)].

**1/4" HEADPHONE JACK** 1/4-inch TRS headphone output. Warning! This output can drive headphones to potentially dangerous levels. [Sleeve = ground, tip = left, ring = right].

**X3/X4 3.5MM JACK** Unbalanced stereo 3.5 mm female connector. Routing determined in the Outputs menu. [Sleeve = ground, tip = X3, ring = X4].

**X1/X2 TA3 JACKS** Line, -10, or Mic level selected in Main menu OUTPUTS section. Routing determined in the Outputs menu. [pin-1 = Ground, pin-2 = hot (+), pin-3 = cold (-). Float pin-3 to un-balance].

**AUX IN 3.5 MM JACK** Auxiliary input used for extra inputs or camera return [Sleeve = ground, tip = left, ring = right].

**MAIN OUTPUTS L (AES 1,2), R (AES 3,4) XLR JACKS** Analog outputs on standard 3-pin XLR-3M connectors. Analog Output levels are selected between Line, -10, and Mic levels in Main menu > OUTPUTS. Can be set to send AES3 digital signals (1,2 and 3,4 on L and R respectively) in Main menu > OUTPUTS. Routing determined in the Outputs menu. [pin-1 = Ground; pin-2 = hot (+); pin-3 = cold (-). Unbalance by floating pin-3].



**REAR PANEL**



**BATTERY 1, BATTERY 2 DOCKING** Sony L-Mount type batteries may be used. When connected to an external DC source via DC the L-Mount batteries can be charged if enabled in the Power menu.

**TOP PANEL**



**TEST CONNECTOR** Used during manufacturing.

# Screen Views

## HOME SCREEN

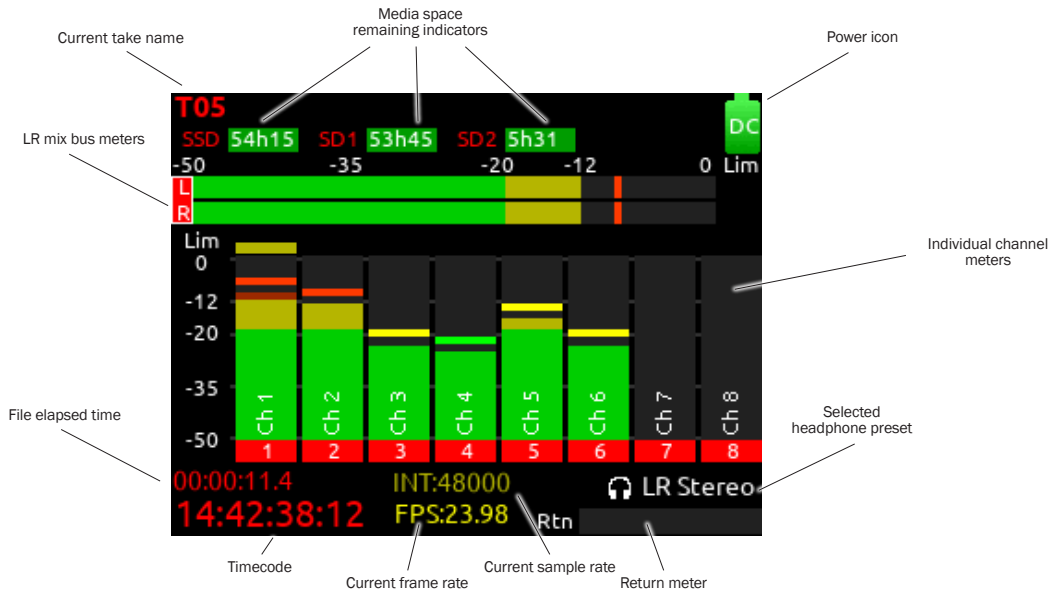

**CURRENT TAKE NAME** Shows the filename of the currently-selected take.

**SSD, SD1, SD2** Indicates the amount of recording time available based on current track count, sample rate, and media routing. The internal SSD drive has a capacity of 256 GB.

**POWER ICON** Indicates approximate voltage condition and current power source being used.

**LR MIX BUS METERS WITH ARM/DISARM INDICATION** Indicates the peak and VU audio levels of the L/R mix. The L and R indicators turn red to indicate that the tracks are armed for record.

**INDIVIDUAL CHANNEL METERS WITH ARM/DISARM INDICATION** Indicates the peak and VU audio levels of the individual channel. May be Pre- or Post- fade depending on Channel to Iso routing. The isolated track indicators turn red to indicate that the tracks are armed for record.

**FILE ELAPSED/ REMAINING TIME** Indicates in Hours:Minutes:Seconds:1/10ths the elapsed time of the current file. During playback, displays the elapsed and remaining time in hours, minutes and seconds.

**TIMECODE** Indicates current SMPTE timecode value in HH:MM:SS:FF.

**CURRENT SAMPLE RATE, FADER/TRIM LEVEL**

1. Indicates current sample rate.
2. Temporarily indicates fader level of last moved fader (red text box).
3. Temporarily indicates trim level of last moved trim (green text box).

**CURRENT TIMECODE FRAME RATE, FADER/TRIM LEVEL**

1. Indicates current frame rate.
2. Temporarily indicates fader level of last moved fader (red text box).
3. Temporarily indicates trim level of last moved trim (green text box).

**SELECTED HEADPHONE PRESET** Indicates the currently-selected headphone preset.

**RETURN METER** Indicates audio level for the return.

**CHANNEL SCREEN**

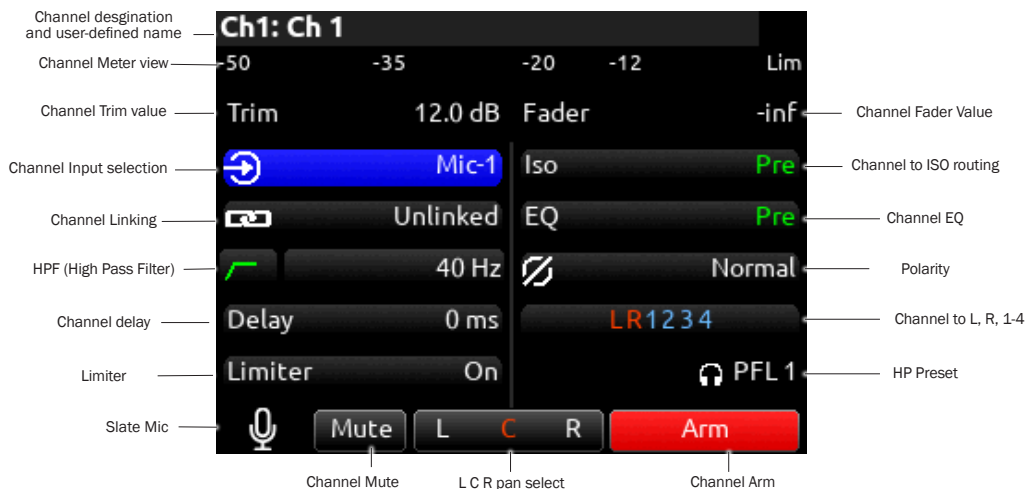

**CHANNEL DESIGNATION AND USER-DEFINED NAME** Indicates mixer channel and user-defined name. Both are overlaid onto the channel audio meter. When in a Channel Screen, hold the PFL Switch for about 0.5 s to enter the virtual keyboard and enter a user-defined name for the channel.

**CHANNEL METER VIEW** Indicates the audio level of the channel. Metering follows ISO Routing selection, Pre- or Post-fade.

**CHANNEL TRIM VALUE** Indicates the gain of the channel trim control. The gain range depends on the type of input selected.

- Mic: +12 to +76 dB
- Line: -14 to +50 dB
- AES3: -10 to +20 dB
- AES42: 0 to +70 dB
- Returns: -20 to +30 dB

Channels 1-6 trim is adjustable using the front panel trim controls. Channels 7 & 8 trims are adjustable in the channel screen using the Select knob.

**CHANNEL FADER VALUE** Indicates the level of the channel fader control, continuously-variable from Off to +16dB.

Channels 1-6 fader is adjustable using the front panel fader controls. Channels 7 & 8 faders are adjustable in the channel screen using the Select knob.

**CHANNEL INPUT SELECTION** Indicates which physical audio input is feeding the channel.

**ISO (CHANNEL->ISO) ROUTING** Indicates where the isolated track's audio is tapped from in the audio chain. Pre- or Post-fade.

**CHANNEL LINKING** Indicates the current linking status. The linking options are Unlinked, adjacent channels (eg. 1,2) and adjacent channels Mid Side (eg. 1-2MS). Linked parameters are: trims, faders, HPF, delay, limiter, mute, ISO, Bus Send 1 and Bus Send 2. Stereo panning is odd to L and even to R. For MS linking, the pan becomes a balance control between M and S.

**CHANNEL EQ** Indicates the EQ position in the audio chain. Pre- or Post-fade. Select to enter Channel EQ screen.

**HPF (HIGH PASS FILTER)** Indicates on/off status where green icon and white value = "On" and grey icon and value = "Off". The HPF frequency is variable in 10 Hz steps from 10 Hz to 320 Hz.

**POLARITY REVERSE** Indicates polarity status. Green icon = polarity reversed, white icon = polarity normal.

**CHANNEL INPUT DELAY** Indicates input delay time. The input delay is continuously-variable in milliseconds from 0-50 ms.

**CHANNEL TO BUS ROUTING** Determines the bus or buses channel audio will be sent. When a channel is routed to a bus as a Send (bus box highlighted blue), the Send Gain value is used. When a channel is sent Pre-fade (green) or Post-fade (orange), the Send Gain value is ignored.

**CHANNEL LIMITER** Indicates on/off status of channel limiter.

**MUTE** Indicates mute status of channel. Blue icon = muted. Toggle mute on/off with the "Tone" switch.

**L C R SELECT** Indicates the stereo pan position of the channel's contribution to the L/R mix. Orange = selected. Use the \*/\*\* switch to select. Hold \*/\*\* switch and rotate Select knob for continuous panning positioning. Alternatively, press and hold Select knob, then use \*/\*\* switch to pan continuously.

**ARM** Toggle then Rtn/Fav switch to arm or disarm isolated track for recording.

**HP PRESET** Pressing in the HP knob toggles between HP preset and PFL.

# Virtual Keyboard

Action	Function
Rotate HP	Scrolls orange highlight through the keyboard characters.
Press HP	Inserts the highlighted character in text field.
'abc' switch	Quick flick toggles between A-Z and a-z in keyboard.
Hold 'abc' switch	Momentary selection of other case.
Delete	Deletes character to the left of flashing cursor.
Hold Delete	Repeatedly deletes characters to the left of flashing cursor.
Space	Inserts space at the flashing cursor position.
Hold Space	Repeatedly inserts spaces.
Save switch	Saves text and exits screen.
Rotate Select	Moves the cursor to the left or right in the text field.
Quick Press Select	Switches to the Shifted functions: Clear, End, Home, Exit. When shifted functions are active, their text changes to white and the non-shifted functions change to gray.
Clear	Clears text from the text edit field.
End/Home	Moves cursor to end/start of text.
Exit	Exits screen without saving text edits.

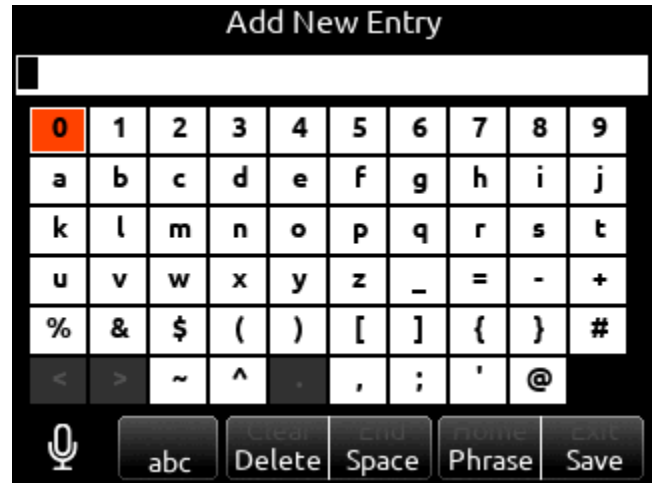

## Phrase Manager

**CLEAR** Clears all phrases

**DELETE** Deletes selected phrases

**NEW** Create new phrase

**EDIT** Edit selected phrase

**INSERT** Inserts selected phrase into text

**REPLACE** Replaces text with current selected phrase

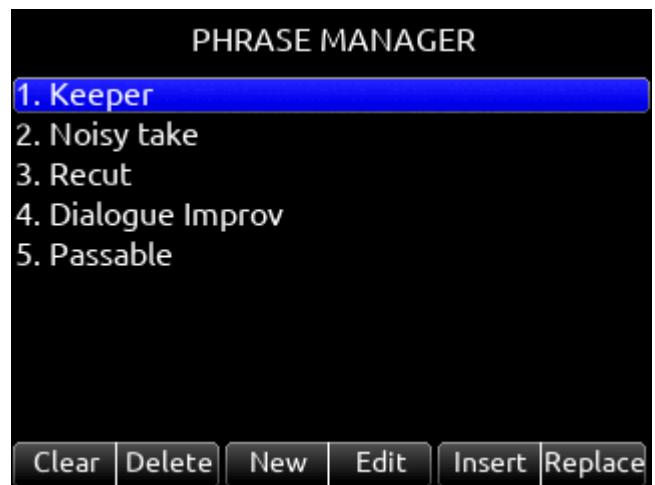

## Channel EQ

- 1. EQ** Selects channel EQ state. [Off\*, On].
- 2. LOW FREQ** Selects low frequency EQ filter parameters.
  - a. Type- Indicates Shelf or Peaking filter [Shelf, Peak].
  - b. Freq- Indicates frequency of the filter, continuously-variable from 20 Hz to 20 kHz (100Hz\*).
  - c. Gain- Indicates gain of the filter, continuously-variable from -15 dB to +15 dB in 1 dB increments (0 dB\*).
  - d. Q- Indicates “Q” or bandwidth of the filter, continuously-variable from .5 - 10 in .1 increments (1.0\*).
  - e. Bypass- Indicates state of the filter [Bypass (orange fill)]\*.
- 3. MID FREQ** Selects mid frequency EQ filter parameters.
  - a. Freq- Indicates frequency of the filter, continuously-variable from 200-20 kHz in 10 Hz increments (5000Hz\*).
  - b. Gain- Indicates gain of the filter, continuously-variable from -15 dB to +15 dB in 1 dB increments (0 dB\*).
  - c. Q- Indicates “Q” or bandwidth of the filter, continuously-variable from .5-10 in .1 increments (1.0\*).
  - d. Bypass- Indicates state of the filter [Bypass(orange fill)]\*.
- 4. HI FREQ** Selects high frequency EQ filter parameters.
  - a. Type- Indicates Shelf or Peaking filter [Peak, Shelf].
  - b. Freq- Indicates frequency of the filter, continuously-variable from 20 Hz to 20 kHz. (100 Hz\*).
  - c. Gain- Indicates gain of the filter, continuously-variable from -15 dB to +15 dB in 1 dB increments (0 dB\*).
  - d. Q- Indicates “Q” or bandwidth of the filter, continuously-variable from .5 - 10 in .1 increments (1.0\*).
  - e. Bypass- Indicates state of the filter. [Bypass (orange fill)]\*
- 5. PRE/POST-FADER** Indicates where the EQ is inserted into the audio chain. Pre-fade or Post-fade [Pre\*, Post]  
*Note: EQ will apply to bus sends when applied Pre-fade only.*



# Menus

## MAIN MENU

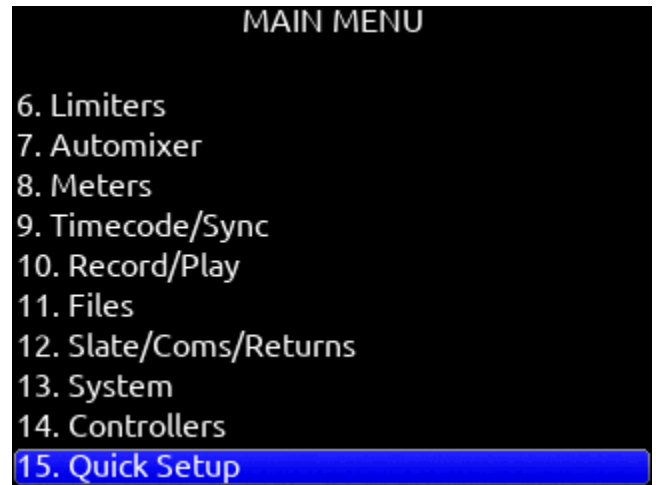
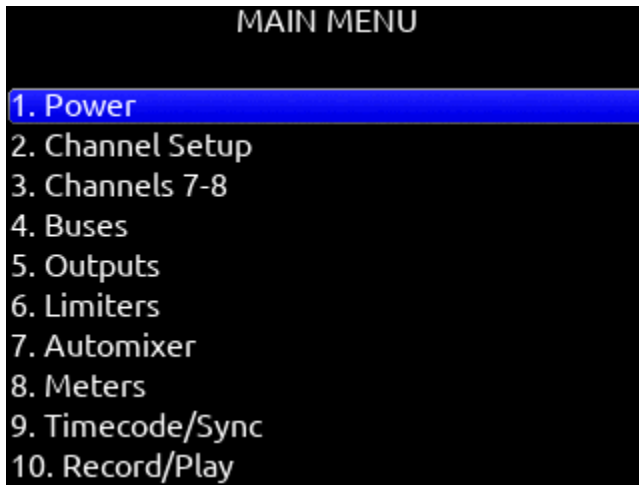

## Power

Allows configuration of various power settings.

**POWER SOURCE ICONS** (Batt1, Batt2, DC, TC Batt,) Indicates the power condition of each power source. [Green = normal, yellow = below normal, orange = low, red = warning]

**1. DC REF** Allows proper power level indicator calibration based upon the type of DC power source used. [12V DC\*, 14 V Li-Ion, 12 V Lead Acid, Full Range (10-18V), Smart Battery].

**2. DC LOSS** Selects how the unit should operate when DC power is lost. [Switch to Next Supply\*, Turn Off].

**3. BATT CHARGING** Selects battery charging mode when connected to an external DC source. [Disabled, When Power Off, When Power On, Always\*].

**4. USB-A CHARGE PORT** Allows charging of compatible external USB devices such as Android tablets [500 mA or 1.5 A\*].

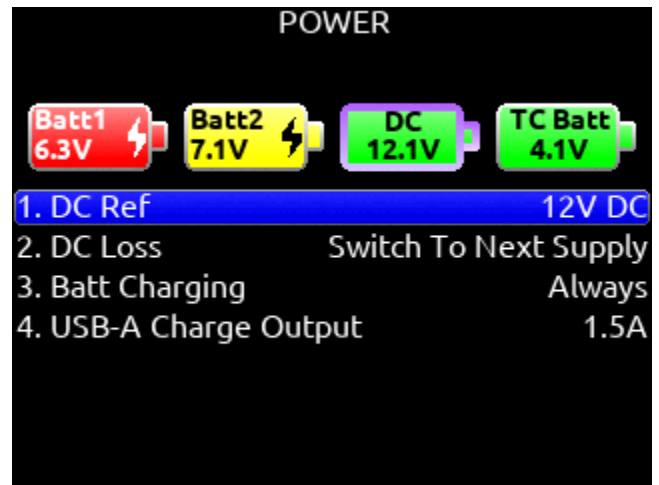

## Channel Setup

**1. PHANTOM VOLTAGE** Selects phantom power voltage for all inputs. [12 V, 48 V\*].

**2. PFL MODE** Selects the source of the PFL feed. [Auto\* Pre-fade, Post-fade] Auto = pre-fade if channel is routed to ISO track pre-fade, post-fade if channel is routed to the ISO track post-fade.

**3. CHANNEL GROUPING** Selects grouping of faders, record arming, and mutes across channels. The lowest channel number in the group controls the other channels grouped. Two channel groups are possible, channels grouped can only be assigned to one group.

- a. Group 1 [1-8]
- b. Group 2 [1-8]
- c. Group 3 [1-8]
- d. Group 4 [1-8]

**4. PFL GAIN** A preset amount of gain that is applied to any channel(s) with active PFL.



## Channel Groups

### CHANNEL GROUPS ENABLE/DISABLE

Provides global enable/disable for each of the four groups in the channel grouping menu. Scroll to Group 1-4 using either knob, then press the knob to enable or disable the group.

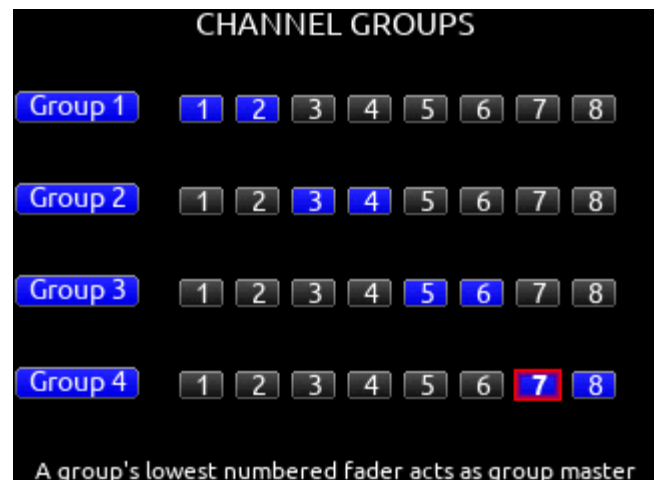



# Buses

Selects routing for Buses L,R and 1-4.

- 1. BUS METER** Audio level meter for the selected bus.
- 2. LINK \*-\*** Selects linking for two odd-to-even numbered adjacent buses. Links bus Gain, Mute Coms, and Mute All functions.
- 3. ISO** Any ISO channel contributes to Bus mix. Green fill in text box = Pre-fade, Orange fill in text box = Post-fade.
- 4. BUS** Not available in L and R Bus Screens. Bus 1 and 2 allow routing of [Bus L or R]. Bus 3 and 4 allow routing of [Bus L, R, 1, or 2].
- 5. COM** Rtn is not available on L,R buses. Bus 1-4 allow Com Rtn to be routed.
- 6. RETURN** Not available on L,R buses. Buses 1-4 allow routing of [Return 1 or 2].
- 7. GAIN** Use \*\* toggle to select and adjust selected bus gain in 1 dB increments. [-inf, -40 to +16 dB].
- 8. MUTE COMS** Selects muting of Coms sends and return.
- 9. MUTE ALL** Indicates mute status of bus. Blue icon = muted. Toggle Mute All On/Off with the “Fav” toggle.

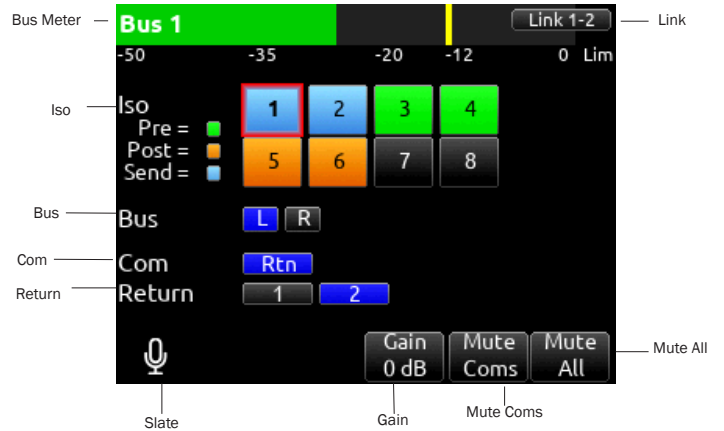
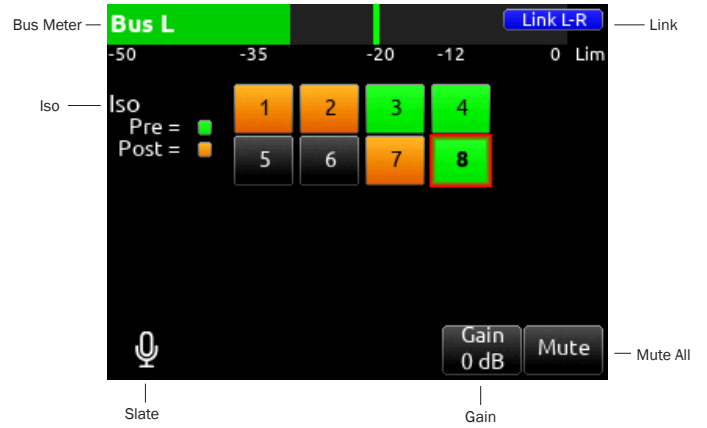

# Outputs

## LR, X1-X4 Output Routing

Selects routing for L,R and X1-X4 outputs [L Out, R Out, X1, X2, X3, and X4 Out] *\*Only a single source can be routed to an Output. If multiple sources need to be routed, use a Bus\**

**A. ISO** Selected source will contribute to the Output. Green = Pre-fade, Orange = Post-fade [1-8].

**B. BUS** [L,R, 1-4, HP-L, HP-R].

**C. COM** Routes Com Return directly to the output.

**D. RETURN** Routes Return 1 or 2 directly to the output.

**E. AUTO-MUTE** Selects automatic muting of the output when in Stop mode. Record and Playback modes are not muted.

**F. DELAY** The output delay is continuously-variable in milliseconds from 0-500 ms.

**G. GAIN** Selects amount of attenuation applied to the output. Toggle the \*\* to select [-infinity, -50 to 0\* dB].

**H. LEVEL** Selects output level type. [Line\*, -10, Mic, AES].

**J. MUTE** Indicates mute status of output. Orange = muted. Toggle Mute On/Off with the “Fav” toggle.

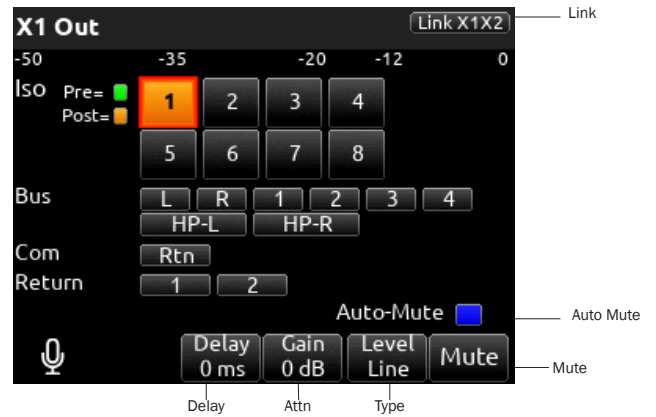

## HP Presets

Selects the list of headphone presets available and allows for editing and creation.

Function	Description
Name	Displays virtual keyboard and allows for naming of the headphone preset.
Edit	Allows selection of routed sources to both HP Left and HP Right. Select HP LEFT or RIGHT and then select desired source. i. Iso- Any source selected will be routed to the selected HP output. Green = Pre-fade, Orange = Post-fade. [1-8] ii. Bus- [L,R, 1-4] iii. Com- [RTN] iv. Return
Mono	Selects monophonic monitoring of selected HP-L/HP-R sources.
MS Stereo	Selects monophonic monitoring of selected HP-L/HP-R sources.
Unlist	De-selects a preset in the list preventing it from being listed in the HP Preset menu (Press HP knob in Home Screen).
List	Selects a preset in the list allowing it to be listed in the HP Preset menu (Press HP knob in Home Screen).
Fav	Selects a favorite preset. The name turns green when selected. The "Fav" switch recalls this HP preset when in the Home Screen.



## Limiters

**CHANNEL LIMITERS QUICK SETUP** Selects the channel limiters on/off status globally. [All On\*, All Off]

**BUS LIMITERS** Selects the bus limiters on/off status globally. On\*, Off]

**CHANNEL RATIO** Selects the ratio of the limiter. [Inf:1, 10:1, 12:1, 14:1, 16:1, 18:1, 20:1\*]

**CHANNEL RELEASE TIME** Selects the release time of the limiters in 10 ms increments. 100 ms\* [50-1000 ms]

**CHANNEL THRESHOLD** Selects the threshold at which the channel limiters activate. -6 dBFS\* [-2 to -12 dBFS]

**BUS RATIO** Selects the ratio of the limiter. [Inf:1, 10:1, 12:1, 14:1, 16:1, 18:1, 20:1\*]

**BUS RELEASE TIME** Selects the release time of the limiters in 10 ms increments. 100 ms\* [50-1000 ms]

**BUS THRESHOLD** Selects the threshold at which the bus limiters activate. -3 dBFS\* [-2 to -12 dBFS]

**BUS LR LINKING** Selects the linking of the L and R bus limiters. [On, Off\*]

**BUS 1,2/3,4 LINKING-** Selects the linking of bus pair limiters. [On, Off\*]

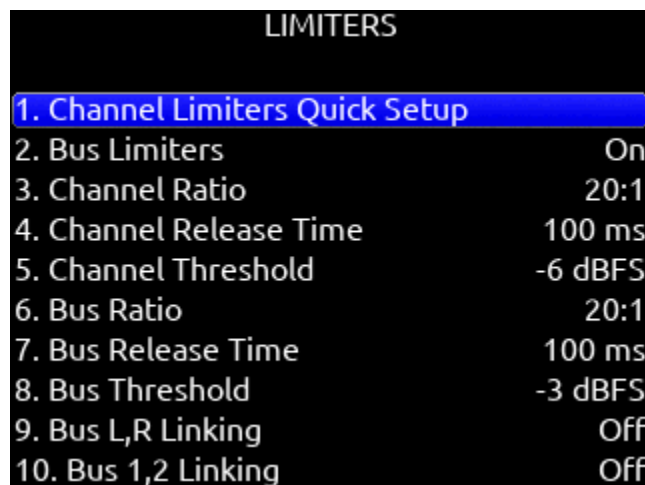

## Automixer

Selects the Automixing mode and the channels included in the auto mixer group(s).

**MODE** Selects the Mode of Auto Mix [Dugan Automixer, Off\*]

**CHANNEL SELECTION** Selects which of channels 1-8 are included into the automix group(s).

Dugan gain display bars is overlaid on top of the channel signal meters. The top 15 dB of the meter scale is shared between Dugan gain display bars and audio signal metering. Dugan gain display bars range from 0 dB (at the top, aligned with 0 dBFS, no attenuation) to -15 dB (max attenuation). The -15 dB value is indicated by a purple horizontal graticule mark to near the top of a channel's signal meter when that channel is enabled for Dugan in Menu>Automixer.

There are two independent Dugan processing groups, Bus L and Bus R. Channels 1-8 can be routed to Bus L, Bus R, both equally (Center), or both unequally (L or R pan increments) by using a channel's pan control.

To show which Dugan group the channel is in, the Dugan gain display bar is left-aligned for fully L, right-aligned for fully R and center-aligned for any other pan value. When a channel is routed to both Dugan groups (Bus L and R), the center-aligned meter bar shows the least attenuated value.

The Channel Screen shows the Dugan meter overlaid within the horizontal channel meter. The Dugan meter scale and indication is the same as in the main meter screen.

The ring LEDs for ch 1-6 show Dugan gain for ch 1-6. The ring LEDs begin to glow purple at 15 dB attenuation and increase in intensity at 0 dB attenuation.

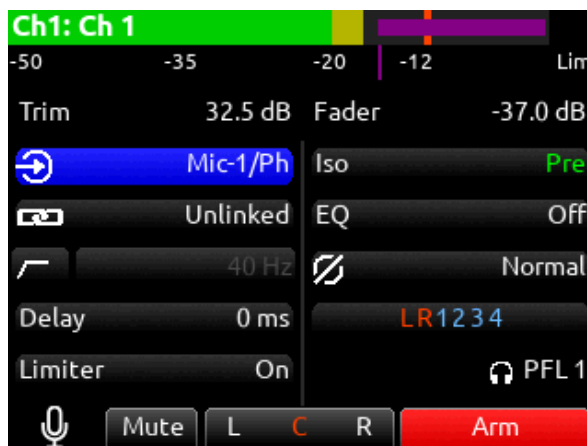
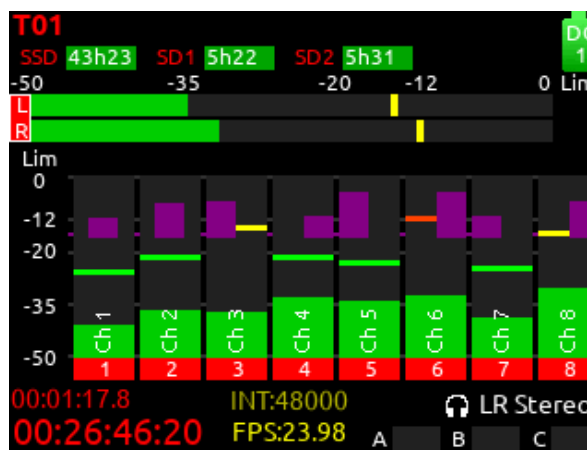
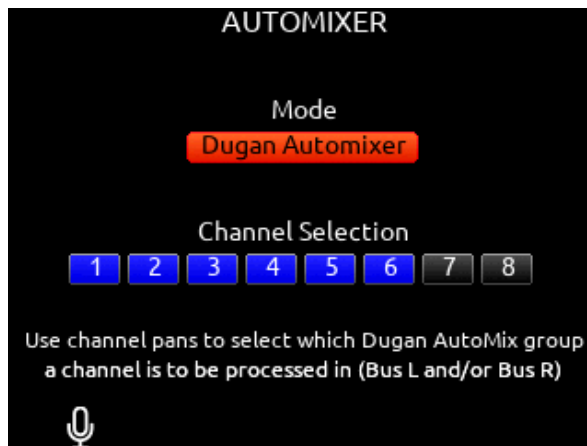

# Meters

## Selected Preset

### METER PRESETS 1-6

**A. PEAK HOLD TIME** Selects the peak hold time for the meter preset. [Off, 1\*-5s., Infinity]

**B. METER RANGE** Selects the range of the meters from bottom to top of scale. [50 dB\*, 40 dB, 20 dB]

**C. METER VIEW** Selects the meters to be viewed in the current preset. [LR,1-8\*, LR 1-8,B1-2,X1-2, LR Out B1-4,X1-4, 1-8 (Horizontal), LR,1-8 (Horizontal), LR Out,B1-4,X1-4(Horiz).

**D. TRACK NAMES** Selects display of track name in meters. [Enabled\*, Disabled]

**E. GRAY METERS** Selects gray meter when record track is disarmed. [When disarmed\*,Off]

METERS	
1. Meter Preset 1	LR,1-8
2. Meter Preset 2	LR,1-8,B1-2,X1-2
3. Meter Preset 3	LR Out,B1-4,X1-4
4. Meter Preset 4	1-8 (Horizontal)
5. Meter Preset 5	LR,1-8 (Horizontal)
6. Meter Preset 6	LR Out,B1-4,X1-4 (Horiz)

# Timecode

**TIMECODE MODE** Selects the timecode mode of operation. [Off, Record Run, Free Run\*, Free Run Auto Mute, Free Run Jam Once, 24 Hour Run (ToD), 24 Hour Run Auto Mute, Ext TC, Ext TC - Auto Record, Ext TC Continuous, Ext TC Cont. - Auto Record]

**FRAME RATE** Selects the current frame rate. [23.98\*, 24, 25, 29.97 ND, 29.97 DF, 30 ND, 30 DF]

**HOLD OFF** Selects the amount of time incoming Timecode needed to be considered valid timecode prior to entering record when in auto-record mode. [0.0\*-8.0 seconds in steps of 0.1 sec.]

**JAM** Indicates the Received TC, Generator TC and the calculated difference between the two. Received and Generator UBits are shown. Jamming to external TC and UBits is supported. Jam TC- Toggle Rtn/Fav switch to jam to external TC.

**SET GENERATOR TC** Provides the ability to start rolling internal TC from a manually entered value in the format of HH:MM:SS:ff.

**SET GENERATOR UBITS** Provides UBits manual and automatic entry. [U=User entered UU:UU:UU:UU\*, mm:dd:yy:UU, dd:mm:yy:UU, Use External] Use Rtn/Fav toggle to exit.

**LEMO OPTIONS** Selects pin-2 and pin-5 options for TC Lemo connector.

a. Pin-2 - [TC In\*, WCK In, WCK Out]

b. Pin-5 - [TC Out, WCK Out]

**SYNC REFERENCE** Selects current sync reference for all transport modes (record, stop and play). [Internal\*, Word Clock, LTC In, AES 1,2,] Ring LEDs flash yellow while locking to the selected sync reference. Once locked, the LEDs will stop flashing. Should the LEDs flash indefinitely, the selected sync reference has not been detected. *Locking can take up to 30 seconds.*

TIMECODE/SYNC	
1. Timecode Mode	Free Run
2. Frame Rate	23.98
3. Hold Off	0.0 s
4. Jam	
5. Set Generator TC	
6. Set Generator Ubits	
7. Lemo Options	
8. Sync Reference	Internal

The 833 will hold timecode for four hours after shutdown.

## Meter View Menu Shortcuts

**WHEN IN LR, OUTPUTS AND LR, BUSES METER VIEWS** Turn the Select knob to scroll to an output or bus. Pressing select acts as a shortcut to that outputs or bus routing screen.

**WHEN IN LR, RETURNS METER VIEW** Turn the Select knob to scroll and press the Select knob to access that Rtn. After selecting, adjusting the knob will adjust the gain.

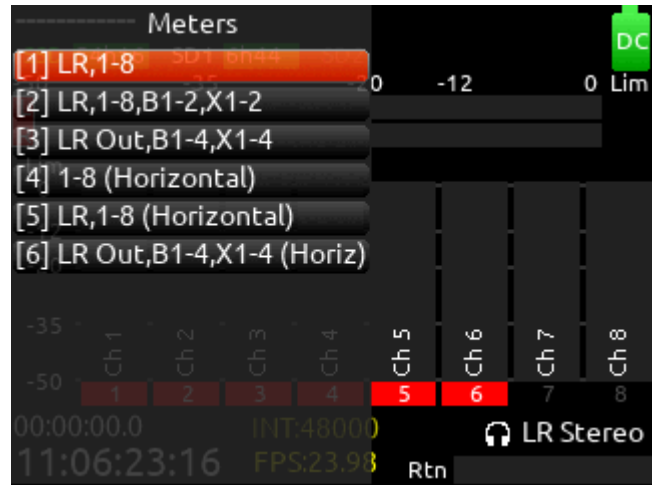

## Record/Play

**SAMPLE RATE** Selects the current sample rate. 12 Track recording is supported at all sample rates. [44100, 47952, 48000\*, 48048, 96000, 192000]

**BIT DEPTH** Selects the current bit depth. [16, 24\*]

**PRE-ROLL TIME** Selects the amount of Pre-roll recording. Adjustable in 1 second increments. [0\*-10 s.] Higher sampling rates reduce the maximum allowed Pre-roll, 2 seconds is available at 192 kHz.

**POST-ROLL TIME** Selects the amount of Post-roll recording. Adjustable in 1 second increments. [0\*-10 s.] If a recording is stopped prematurely, press record within the post-roll time. The machine will continue to record into the original file. Useful for when directors call 'cut' prematurely. During the post roll period, the transport joystick ring LED shows orange. Pressing stop again during the post-roll period cancels the post roll and stops recording.

**TRACK TO MEDIA MENU** Selects the sources for each recording media as well as the WAV file type recorded. Tracks may be routed to media to be recorded as Mono or Poly files. (Green fill in text box= Mono file, Blue fill in text box= Poly file)

- a. SSD- [ISO, L/R, Bus1/2, ALL]
- b. SD1- [ISO, L/R, Bus1/2, ALL]
- c. SD2- [ISO, L/R, Bus1/2, ALL]

*\*\*Monophonic file recording up to 48.048 kHz.*

**DEFAULT PLAYBACK DRIVE** Selects the drive for playback. [SSD, SD1, SD2]

**PLAYBACK TAKE FROM TAKE LIST** Enter the take list and select a take with either knob. Pressing play will playback the selected take.

**ARMING/DISARMING DURING RECORDING** All channels can be armed/disarmed while recording. This creates a seamless split to a new file or files. The split takes will be suffixed with an incrementing alphabetic character. i.e. A, B, C...

**AUTO-SPLIT** Takes that are auto-split due to the 4 GB limit of BWF format are also suffixed using the same A, B, C...incrementation.

**RECORD SPLIT** Takes that are split when pressing record during recording increment the file's take number.

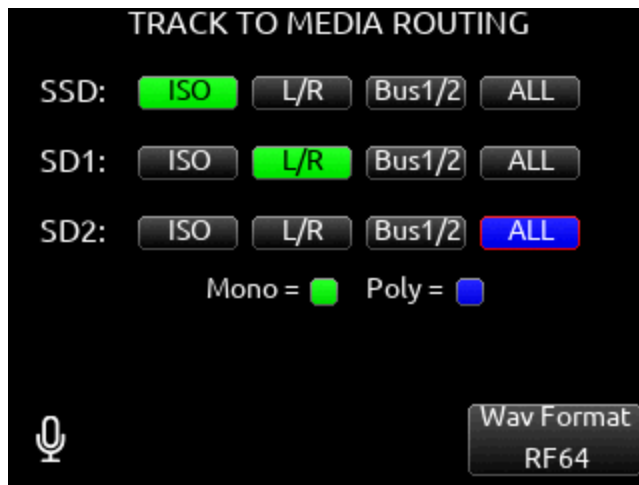

# Files

**USB FILE TRANSFER** Enters USB file transfer mode. Files may be transferred between a Mac or PC and the 833 via USB-C port. *When in USB file transfer mode, playback, record and controller functions are suspended.*

**TAKE LIST** Enters the Take List. The Take List shows a running list of recorded takes in chronological order with most recent at the top. Various details of each take are indicated on the right side of the display: TC (timecode), Duration, Media, Folder, Scene, Take, Date, and Notes. From this list, takes may be selected for metadata editing by using the Rtn/Fav toggle to access the Take Edit Menu.

**RECORD FOLDER** To select or create a Record folder, go to the Take List > Next Take Edit Screen and select REC FOLDER using the \* or \*\* Toggle switch. A Record Folder stores recorded takes (audio files) and sound reports. Record Folders can be created and nested up to three levels deep. A new or existing Record Folder can be selected for recording into.

There are 4 types of Record Folder:

1. None: Files are stored at drive root. When 'None' is selected, the Date is embedded as Tape metadata.
2. Custom: Files are stored in a custom-named folder; the Custom folder name is embedded as Tape metadata in the recorded audio files.
3. Project: Files are stored in a folder with a name determined by the Project name entered in the Take List > Next take Edit Screen. The Project folder name is embedded as Tape metadata.
4. Daily: files are stored in a folder whose name is in the format yyYmmMdd. When a Daily folder is selected, the Date is embedded as Tape metadata.

When the monophonic wav file format is selected (in the Record/Play > Track to Media Routing menu), all mono files created for a take will follow the naming of the take and be placed in a take folder within the selected record folder.

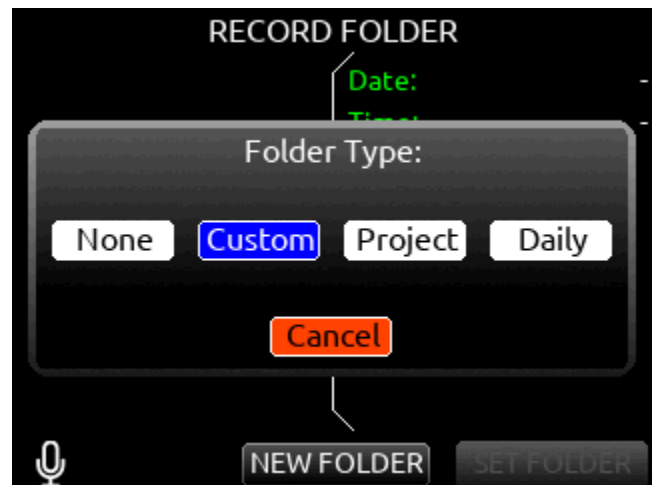
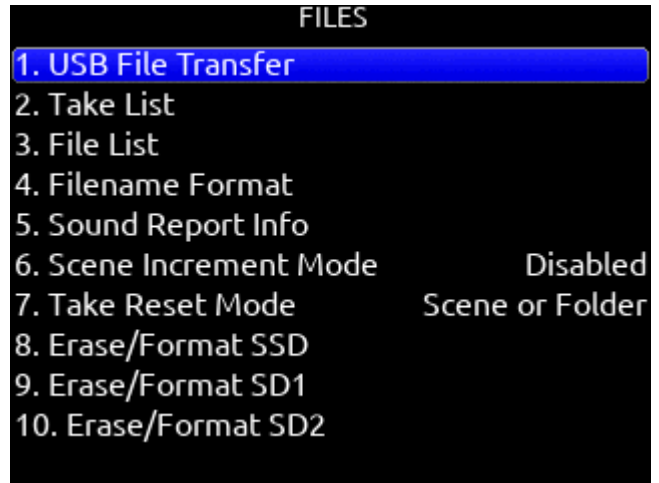



**TAKE EDIT MENU**

1. Notes: Edit notes for the selected take. Maximum 200 characters including Sticky Notes.
2. Sticky Notes (next take only): edit sticky notes that are automatically prepended to subsequent takes. Maximum 50 characters.
3. Scene: Edit scene name. Maximum 50 characters.
4. Take: edit Take Number.
5. Circle (current or previous takes only): circle a take. Prepends "@" symbol to take name.
6. Project Edit: Project name. Maximum 20 characters. This will become the record folder name if Project is selected as the Folder Type.
7. Delete (current or previous takes only): moves a selected take to a drive's Trash folder.
8. Track Names: edit track names. Maximum 20 characters.

**FILE LIST** Enters the File List. The File List displays the 833's internal SSD and SD cards and their contents. Various details of each drive, folder, and WAV file are indicated on the right side of the display: TC, FPS:, duration, format, tracks, date, time, and size.

**FILENAME FORMAT** Selectable naming conventions for recorded files. Selectable between Scene (Slate) [T,+,-] Take, or Project [;, %, =] Scene (Slate) [T,+,-] Take.

**SOUND REPORT INFO** Selects the various content for each field of a sound report.

**SCENE INCREMENT MODE** Defines whether a scene name shall be incremented numerically or alphabetically when the scene increment shortcut is used.

**TAKE RESET MODE** Selects when a Take Number shall reset to 1. Options are: Never, Scene Change, Folder Change, Scene or Folder Change.

**ERASE/FORMAT SSD** Select to erase/format the internal SSD.

**ERASE/FORMAT SD1** Select to erase/format SD1.

**ERASE/FORMAT SD2** Select to erase/format SD2.

All created folders will be placed on the root of the media. All mono files created for a take will follow the naming convention of the take and be placed in the take folder.

**FOLDER NAME/TAPE METADATA**

When a Project folder is selected, the Project is embedded as Tape metadata.

When a Custom folder is selected, the Custom folder name is embedded as Tape metadata.

When a Date or "None" folder is selected, the Date is embedded as Tape metadata.

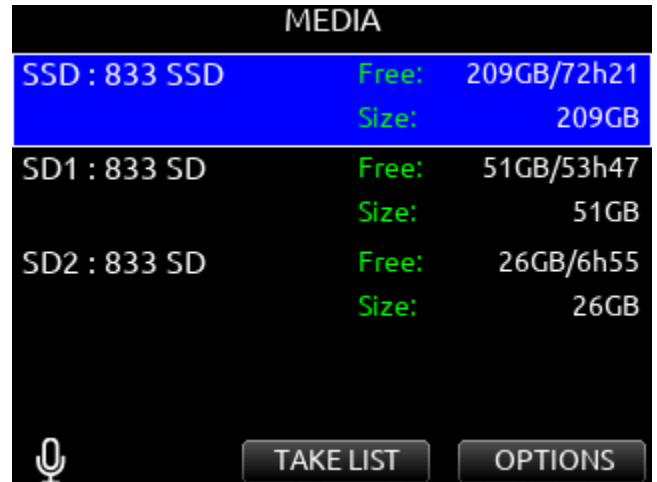

## File List

Allows navigation and management of files and folders on the SSD, SD1 and SD2 drives.

## File List Options

**COPY FOLDER/FILE** Provides support for copying Folders and Files between drives from the File List's Options Menu.

**DELETE FOLDER/FILE** Delete Folders and Files from the File List's Options Menu.

**CREATE SOUND REPORT** Creates a CSV sound report for the selected folder's takes.

**EMPTY TRASH** Empties the trash folder.

**EMPTY FALSE TAKES** Empties the false takes folder.

**ERASE/FORMAT** Formats the selected drive.

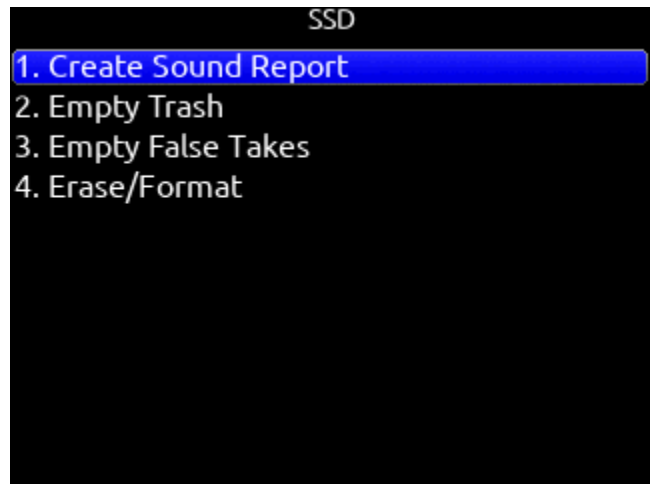
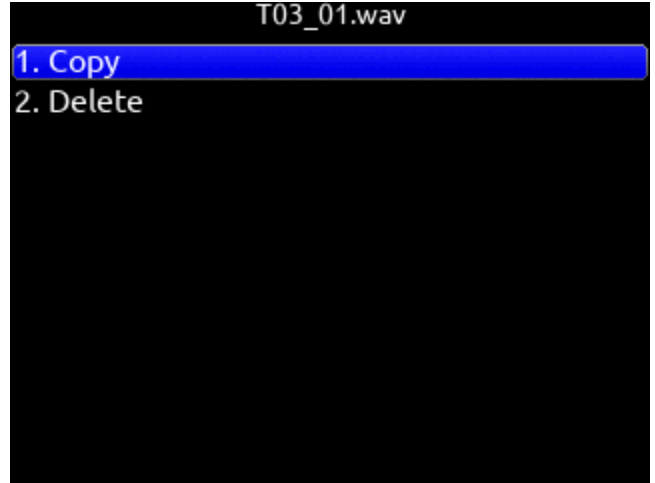

## Slate/Coms/Returns

**SLATE/COM MIC SOURCE** Selects the slate and com mic source. [Off, Int Mic\*, Ext Mic, Ext 12 V Mic]

**SLATE/COM MIC GAIN** Selects the gain for the slate/com mic. [0-20 dB in 1 dB steps for the internal mic, 0-60 dB in 1 dB steps for the external mic].

**SLATE ROUTING** Selects the destination(s) for the slate mic.

- a. Track- [1-6]
- b. Output- [L,R, X1-X4]
- c. Bus- [L,R, 1-4]
- d. HP- [HP-L, HP-R]
- e. Duck Bus Prgrm By: [0- -40 dB, -inf]
- f. Duck HP Prgrm By: [0- -40 dB, -inf]

**COM SEND ROUTING** Selects the destination(s) for Com Send 1.

- a. Output- [L,R, X1-X4]
- b. Bus- [L,R, X1-X4,]
- c. HP- [HP-L, HP-R,]
- d. Duck Bus Prgrm By: [0- -40 dB, -inf]
- e. Duck HP Prgrm By: [0- -40 dB, -inf]

**COM RTN GAIN** Selects the gain for COM RTN in 1 dB increments. [0-30 dB]

**RTN GAIN** Selects the gain for RTN in 1 dB increments. [0-30 dB]

**DUCK BUS PROGRAM BY** Ducks all audio sent to the bus by a user defined amount .

**DUCK HP PROGRAM BY** Ducks all audio sent to headphones by a user defined amount.

*When sending coms or slate signal to outputs the program routed to that output is replaced by the com or slate signal.*

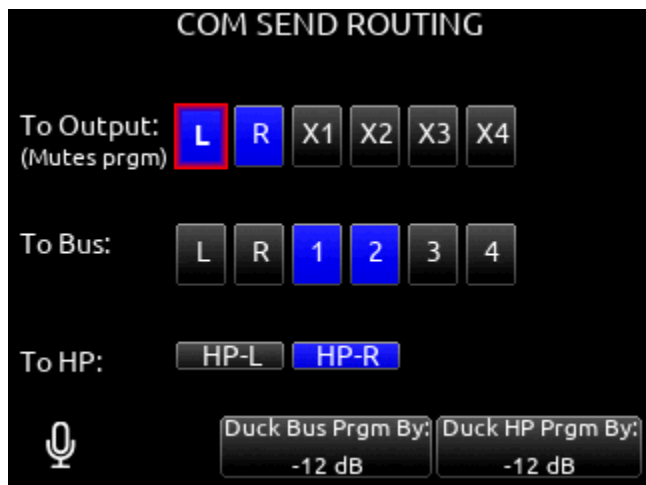
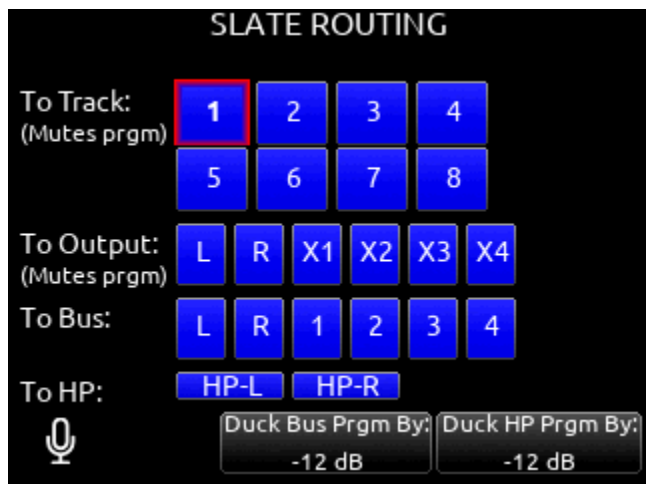
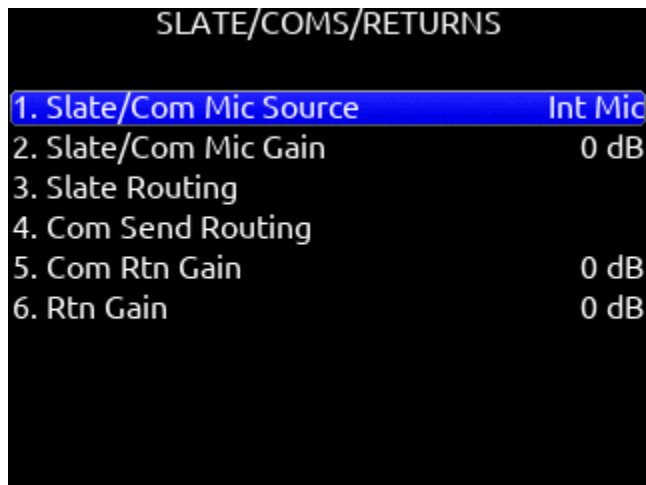

# System

**tone SETUP** Selects the level, frequency, and routing of the internal tone generator.

- a. Level- Selects the level of the tone generator from -20 - 0 dBFS in 1 dB increments. [-20 - 0 dBFS]
- b. Frequency- Selects the frequency of the tone from 100 to 10 kHz in 10 Hz steps. [100-10 kHz]
- c. Track- [1-8]
- d. Output- [L,R, X1-X4]
- e. Bus- [L,R, 1-4]

**NOTIFICATION BELLS** Selects settings for the notification bells.

- a. To HP- Routes notification bell tones to the headphones. [HP-L, HP-R]
- b. To Bus- Routes notification bell tones to the buses. [L,R, 1-4]
- c. When...- Selects when the notification bell tones are used. [Rec/ Stop, Space Low, Power Low, Warning Popup].
- d. Level- Selects the level at which the notification bell tones will be played in 1 dB increments. [Muted, -60 to -12dBFS]

**FADER CALIBRATION** Selects the option to manually calibrate all faders.

**BRIGHTNESS** Selects the brightness of the LED display and front panel LEDs.

- a. LED Brightness- Selects the front panel LED brightness in 10% steps. [10%-100%].
- b. Selects the front panel LCD display brightness in 10% steps. [10%-100%].

**TIME/DATE** Selects the current date and time.

- a. Time Format [12\*, 24 hr].
- b. Date Format [mm/dd/yy\*, dd/mm/yy, yy/mm/dd].
- c. Set Time/Date Selects the current date and time.
- d. Time Zone [-12 to +13 hours GMT].
- e. Daylight Saving [On, Off\*].

**TOGGLE SWITCH ACTION** Chooses what function is assigned to the toggle switches.

**VERSION INFO** Indicates current firmware version.

**REGULATORY** Displays relevant compliance information.

**FIRMWARE UPDATE** Selects any \*PRG update files present on any media.

**MENU + PFL SWITCH ACTION** Chooses what menu is assigned to a Menu + PFL Switch action.

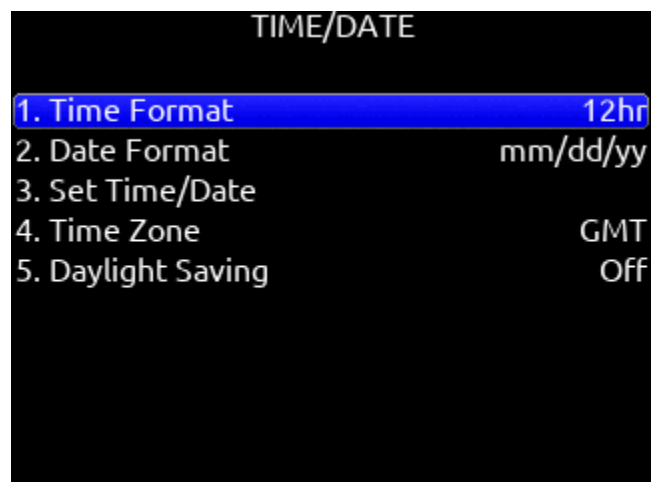
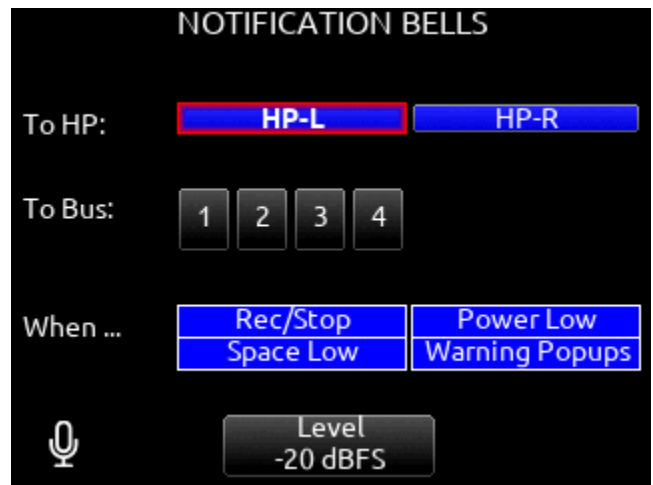
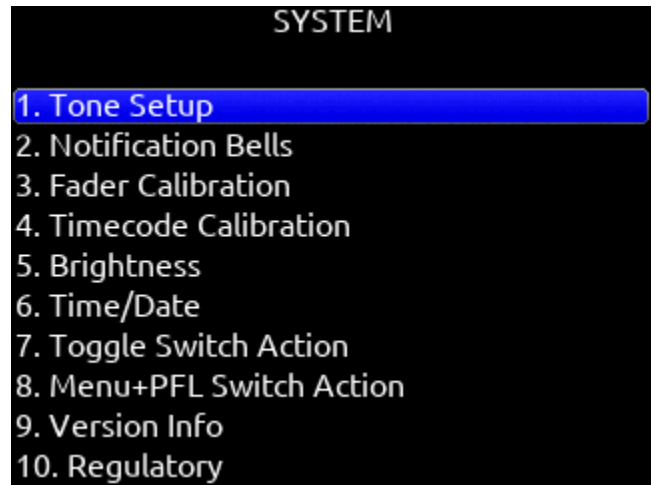

# Controllers

**MAPPING** Selects Mapping menu.

- a. Name: Allows for custom naming of controller button.
- b. MIDI: Toggles between the button name and MIDI code of the selected button function.
- c. Load: Loads a saved button mapping preset.
- d. Save: Saves a button mapping preset to any/all media. Toggle “Fav” after media selection to save.
- e. Learn: Selects learn function. To use, toggle Learn and press the desired button to be learned on the controller. Once the button has been learned, press the HP encoder to scroll through the possible list of available functions (shown below) that can be assigned and select the desired function.
- f. Reset: Deletes the currently selected button mapping in the Mapping menu.

**REQUIRE SHIFT FOR ARM** When selected, “Shift” on external control surface must be pressed simultaneously with “Rec” to arm tracks. [Off\*, On]

**DISPLAY CH. FADER GAINS** Selects whether the fader gains are displayed in the controller’s display. [Off, On\*]

**Solo Follows Select:** Selects whether solo (PFL) mode is engaged on a channel when pressing “Select” from the controller. [Off, On\*]

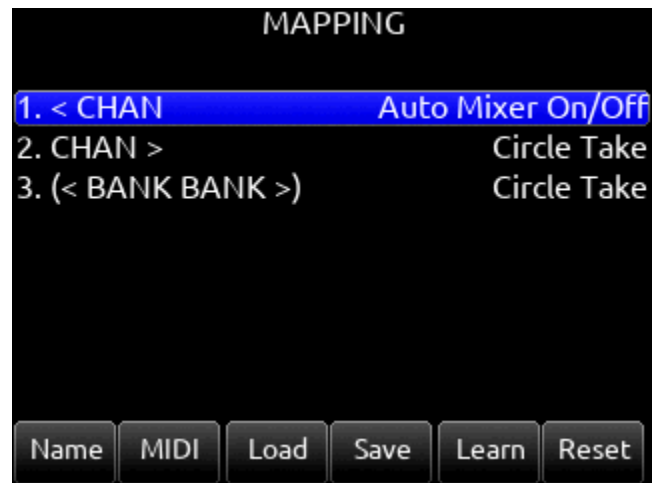
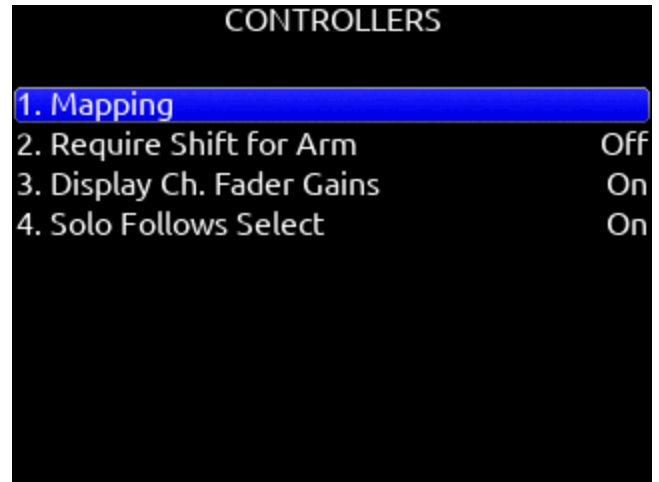

The 833 supports some third-party external controllers that conform to the MCU protocol. Two controllers may be connected simultaneously for extended control.

**ICON PLATFORM M+ AND D2 DISPLAY** Eight channel fader bank with control over gain, bus, sends, coms, trim, and pan. Dedicated Select, Mute, Solo, and Arm buttons for each channel.

**ICON PLATFORM X+** Eight channel fader bank with single assignable knob and Select, Mute, Solo, and Arm buttons.

**ICON PLATFORM B+** Assignable illuminated 50 pad button surface. The platform B+ can be attached to the Icon Platform M+ via the 6-pin mini DIN cable.

**BEHRINGER X-TOUCH** Eight channel trim and fader panel with master volume and additional mappable buttons.

**MACKIE MCU PRO** Eight channel trim and fader panel with master volume and additional mappable buttons.

In addition, any MCU controller may have its buttons custom-mapped to perform any of the following actions on 833:

Function	Action
Auto Mixer On/Off	Toggles the Auto Mixer on/off
Bus Mode	Bus Masters
Channel Groups Edit	Create/Edit channel groups
Channel Sends on Faders	Shortcut to put Bus sends on linear faders/toggle on/off
Channel Source Edit	Patch input to channel
Circle Take	Circle take
Com	Activates Com Send
Com Rtn	Activates Com Rtn
EQ Mode	Spills EQ parameters over scribble strips, Fader Bank right to view last parameter. Push and hold V-Pot 1 to toggle EQ on/off, push each band's amplitude V-Pot to toggle on/off each band, push each band's Q V-Pot to toggle eq type Shelf/Peak
False Take	Activates False Take function
Fat Ch. Mode	Spills fat channel parameters across scribble strips
Fav HP Preset	Recalls Fav HP Preset from Main Menu>Outputs>HP Presets
Fav Toggle	Emulates Fav toggle on 833
Home	Activates Home screen and Trim encoders mode
HP Presets Menu	Shortcut to Main Menu>Outputs>HP Presets
Jog is HP	Switches Jog wheel to emulate HP knob on 833
Jog is Select	Switches Jog wheel to emulate Select knob on 833
Jog Wheel Press	Acts as "Select" while using jog wheel
L-ident	Identifies left channel output by varying amplitude vs. right channel with constant amplitude
Menu	Emulates the Menu button on 833
Meters	Emulates the Meter button on 833
Mic Toggle	Emulates the Mic toggle on 833
Mix Pan Mode	Activates all V-Pots to Pan mode on every channel. Push to center pan
Mix Trim Mode	Activates all V-Pots to Trim mode on every channel. Push to enter pan mode
Nav Down	Moves the highlighted selection up one in matrix screens, emulates HP encoder down in Home screen
Nav Left	Navigates back to previous screen
Nav Right	Selects the currently highlighted selection
Nav Up	Moves the highlighted selection down one in matrix screens, emulates HP encoder up In Home screen
Out Mode	Selects the output masters mode
Play Remain Time	Selects the remaining time in the LED timecode display

Rtn	Selects Rtn toggle on/off
Rtn Toggle	Emulates the Rtn toggle on 833
Scene Inc	Brings up the Scene Inc Dialog box for incrementing Scene Name according to the setting in Files>Scene Increment Mode
Scene Name Edit	Brings up the Scene Name Edit virtual keyboard screen for editing the current take's scene during record and the next take's scene during stop
Select	Selects the currently highlighted selection in menus and matrix screens
Slate	Toggles Slate on/off
Take List	Brings up the Take List
Take Notes Edit	Brings up the Notes Edit virtual keyboard screen for editing the current take's notes during record and the next take's notes during stop
Take Number Edit	Brings up the Take number edit screen for editing the current take number, during record and the next take number during stop
Timecode Jam	Brings up the Timecode Jam screen
Toggle Jog is Select	Toggles between Select and HP encoder press on 833
Tone	Toggles tone on/off
Tone Toggle	Emulates Tone toggle on 833
* Toggle	Emulates * toggle on 833

## Toggle Switch Action

**MIC/SELECT + MIC/HP + MIC** Selects Slate, Com Send, or No Action.

**TONE/SELECT + TONE** Selects Continuous Tone, L-ident Tone or No Action.

**\*/\*\*** [Jam Menu, Circle Take, Slate, Com Send, Rtn, Com Rtn, Auto Mixer On/Off, Scene Name, Take Notes, Take Number, No Action]

**RTN/SELECT + RTN/HP + RTN** [Rtn, Com Rtn, Fav HP, No Action]

**FAV/SELECT + FAV/ HP + FAV** [Rtn, Com Rtn, Fav HP, No Action]

1. Mic Action	Slate
2. Select + Mic Action	Com Send
3. HP + Mic Action	No Action
4. Tone Action	Continuous Tone
5. Select + Tone Action	L-Ident Tone
6. * Action	Automixer On/Off
7. ** Action	Automixer On/Off
8. Rtn Action	Rtn
9. Select + Rtn Action	No Action
10. HP + Rtn Action	No Action

## Menu + PFL Switch Action

**MENU+PFL SWITCH [1-6]** [Power Menu, Channel Setup Menu, Channel Grouping, Channels 7-8 Menu, Buses Menu, Outputs Menu, LR, X1-X2 Output Routing, L Out, R Out, X1 Out, X2 Out, X3 Out, X4 Out, HP Presets, Limiters Menu, Meter Presets Menu, Meter Preset 1-6, Timecode/Sync Menu, Jam Timecode, Set Generator TC, Set Generator Ubits, Lemo Options, Record/Play Menu, Track To Media, Files Menu, File List, Take List, File Name Format, Sound Report Info, Slate/Coms/Returns Menu, Slate Routing, Com Send Routing, System Menu, Tone Setup, Notification Bells, Brightness, Time/Date Menu, Toggle Switch Action, Menu+PFL Switch Actions, Controllers Menu, Auto Mixer On/Off, Take Number, Take Notes, Scene Name]

1. Menu+PFL 1	Power Menu
2. Menu+PFL 2	Channel Setup Menu
3. Menu+PFL 3	Channels 7-8 Menu
4. Menu+PFL 4	Buses Menu
5. Menu+PFL 5	Outputs Menu
6. Menu+PFL 6	Limiters Menu

	Power Menu
	Channel Setup Menu
1. Menu+PFL 1	Channel Grouping
2. Menu+PFL 2	Channels 7-8 Menu
3. Menu+PFL 3	Buses Menu
4. Menu+PFL 4	Outputs Menu
5. Menu+PFL 5	LR, X1-X4 Output Routing
	L Out
	R Out
	X1 Out
	X2 Out



Menu + PFL Shortcuts	Action
Menu + PFL 1	Power
Menu + PFL 2	Channel Setup Menu
Menu + PFL 3	Channels 7-8 Menu
Menu + PFL 4	Buses Menu
Menu + PFL 5	Outputs Menu
Menu + PFL 6	Limiters Menu

The Menu + PFL Shortcuts are set by default. They can be customized by going to System > Menu + PFL Switch Action.

Toggle Switch Shortcuts	Action
Mic Toggle	As defined in the System/Toggle Switch Action menu. Default: Slate
Sel + Mic Toggle	As defined in the System/Toggle Switch Action menu. Default: Com Send
Meter + Select or Select + Meter	Arm or disarm Selected track.
*/** Toggle	As defined in the System/Toggle Switch Action menu. Default: No Action
Rtn Toggle	As defined in the System/Toggle Switch Action menu. Default: Return
Sel + Rtn Toggle	As defined in the System/Toggle Switch Action menu. Default: No Action
HP + Rtn Toggle	As defined in the System/Toggle Switch Action menu. Default: No Action
Fave Toggle	As defined in the System/Toggle Switch Action menu. Default: Fav HP
Sel + Fav Toggle	As defined in the System/Toggle Switch Action menu. Default: Com Rtn
HP + Fav Toggle	As defined in the System/Toggle Switch Action menu. Default: No Action

## USB Keyboard

A USB keyboard may be connected to the 833 via the USB-A port. The keyboard may be used for metadata entry as well as the following shortcuts:

Keystroke	
F1	Enters Main Menu
F2	Enters Take List
F3	Toggles Meter Views
Ctrl+R	Record
Ctrl+S	Stop
Space Bar	Play/Pause
Up arrow	Emulates HP encoder rotate clockwise in most screens except channel screen where it emulates the Sel encoder rotate clockwise. Channel screen and matrix screens: navigates up HP vol in home screen, row selection in menus, parameter adjust
Down arrow	Emulates HP encoder rotate anticlockwise in most screens except channel screens where it emulates the Sel encoder rotate anticlockwise Channel screen and matrix screens: navigates down HP vol in home screen, row selection in menus, parameter adjust
Enter	Home Screen: Emulates HP encoder press i.e. HP Monitor Source Select List Menu screens: Emulates HP encoder press i.e. Activates selection Channel screens: Emulates HP encoder press Virtual Kybd: OK
Ctrl+Up arrow	Emulates Sel encoder rotate clockwise
Ctrl+Down arrow	Emulates Sel encoder rotate counterclockwise
Ctrl+Enter	Emulates Sel encoder press
Ctrl+P	Screenshot of current screen

## Quick Setup

**LOAD GLOBAL SETTINGS** Selects a saved settings file for loading.  
[User-saved Global settings]

**SAVE GLOBAL SETTINGS** Saves Global settings to various destinations. [SSD Drive (internal), INT1-4 (internal), SD1 and SD2]

**LOAD FACTORY SETTINGS** Selects factory settings to be loaded for entire unit.

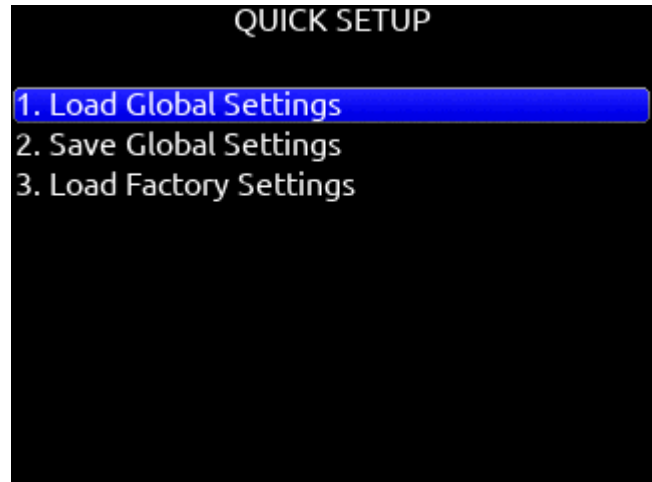

## USB-A

USB-A allows multiple devices to be used to control and monitor various functions of the 833. Should multiple devices be used simultaneously, the use of a USB-A type hub is required.

## USB C

USB-C allows for high-speed file transfer between a computer and any of the 833's media.

*Note: All other functionality is suspended in USB File Transfer mode.*

# SD-Remote

SD-Remote is an Android tablet application, available in the Google Play Store, designed to pair with the 833. SD-Remote offers control and display parameters, including the following:

1. Channel Meters
2. L/R Meters
3. Channel Name
4. Channel Solos/Mutes
5. Channel Record Arm/Disarm
6. Transport Controls
7. Metadata Editing
8. Info
9. Timecode
10. Take List
11. Reports

## SETUP PROCEDURE

1. Download and install SD-Remote from the Google Play Store.
2. Connect Android tablet to the 833 via USB-A port.
3. On the Android tablet, open the quick settings drop down menu.
4. Touch "USB Android System" twice to open "Use USB to" dialog box.
5. Touch "Connect a MIDI device."
6. Open SD-Remote app.

*"No USB Connection" popup will appear when SD-Remote does not detect presence of an 833 Unit.*

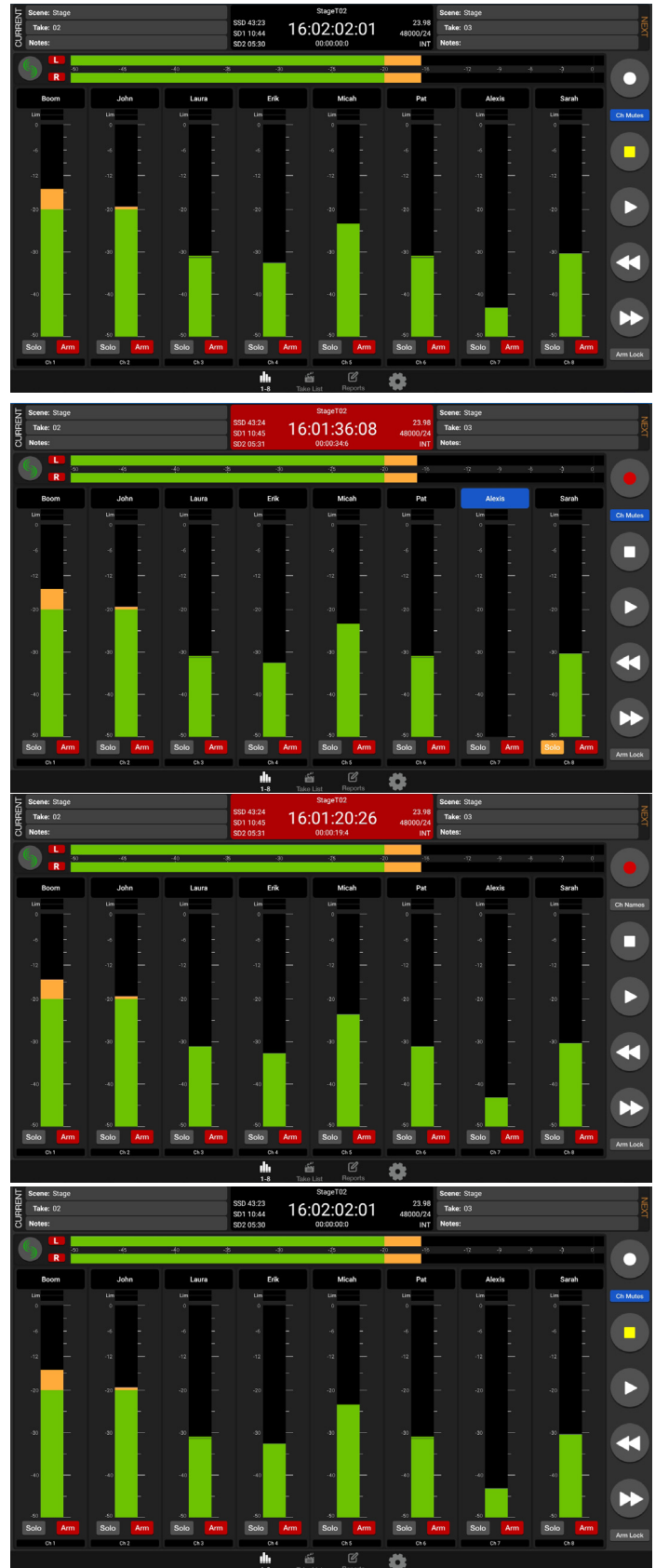

# SD-Remote Take List

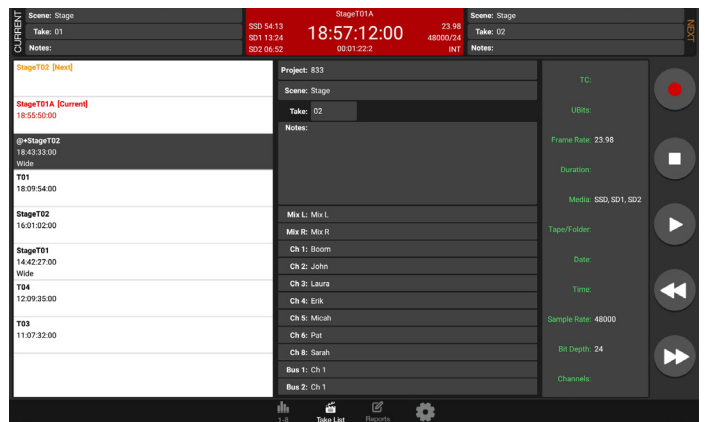
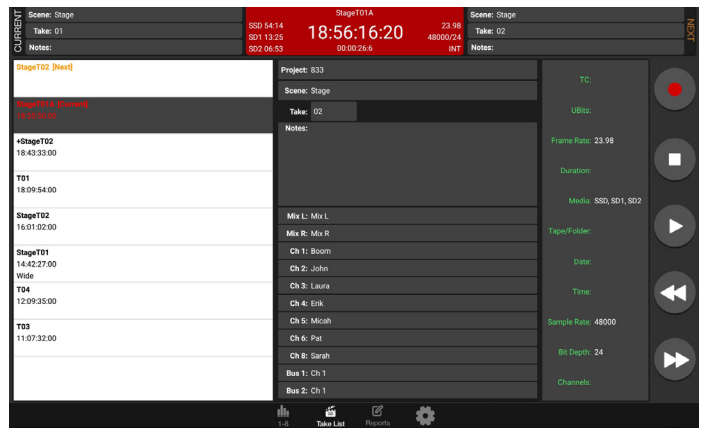

# SD-Remote Sound Report

## CREATE SOUND REPORT

1. Touch “Reports” icon on the bottom of the screen.
2. Select the source(s) from which the desired info resides. Sibling folders (folders at the same directory level) may be included in the same report by ticking “Sibling Folders.”
3. Select “Email” to email as CSV file. Additionally, a PDF file may be mailed by selecting the “Include PDF” option.
4. Touch the “Create Report” button. The Sound Report(s) will be placed into a ZIP file to be emailed while simultaneously creating the report on the selected source drives.

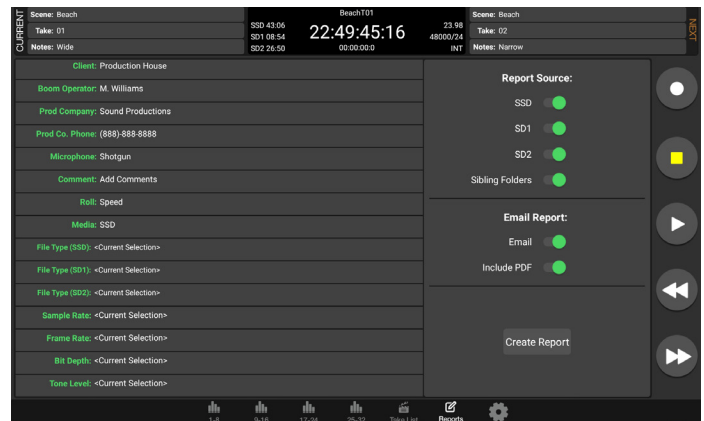
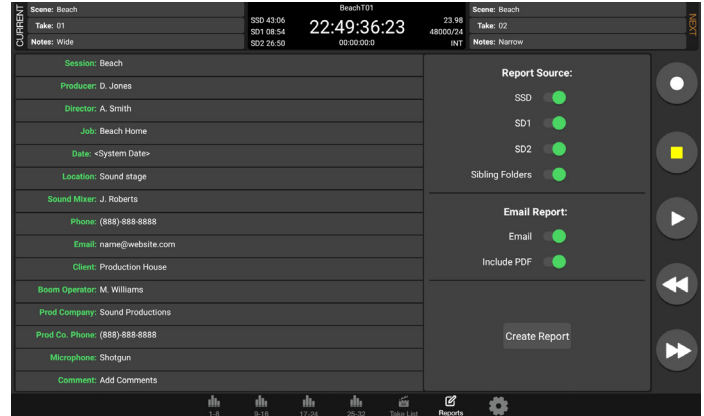



# Specifications

Specifications are subject to change without prior notice.  
For the latest information available on all Sound Devices products,  
visit our website: [www.sounddevices.com](http://www.sounddevices.com).

## FREQUENCY RESPONSE

10 Hz to 80 kHz  $\pm$  0.5 dB (192 kHz sample rate, re 1 kHz)

## THD + NOISE

0.005% max (mic in, 1 kHz, 22 Hz–22 kHz BW, trim at 20, fader at 0, -10 dBu in)

## EQUIVALENT INPUT NOISE

-131 dBV (-129 dBu) max (mic in, A-weighting, 76 dB gain, 150 ohm source impedance)

## PROCESSING ENGINE

Highly extensible, full FPGA-based audio processing, 3 FPGAs  
Six-way ARM multiprocessor system  
64-bit audio processing precision

## INPUTS

Mic/Line inputs: 6 total, all fully featured; 3 on full-size XLR, 3 on TA3  
Mic-level inputs: (XLR, TA3): Class-A, discrete differential long-tail pair, 4k ohm input impedance  
Line-level inputs: (XLR, TA3,): active-balanced, 4k ohm input impedance  
48V phantom: full 10 mA to all 6 inputs simultaneously  
AES3 or AES42 available on XLR input 1  
AES42: +10 V, 250 mA available, mode-1, auto-ASRC  
Aux (3.5 mm): unbalanced 2-channel, 4k ohm input impedance  
Com Rtn (TA3, 3.5mm) balanced, 1-channel, 8k ohm input impedance  
External Slate Mic (TA5): balanced, 8k ohm input impedance, menu-selectable 12 V phantom

## MAXIMUM INPUT LEVEL

Mic: +8 dBu (2.0 Vrms)  
Line: +28 dBu (19.5 Vrms)  
Aux: +18 dBu (6.2 Vrms)  
Com Rtn: +24 dBu (12.3 Vrms)  
External Slate Mic: +12 dBu (3.2 Vrms)

## HIGH-PASS FILTERS

Adjustable 10 Hz to 320 Hz, 18 dB/oct. 1st stage analog (before preamp), 2nd stage digital.

## LIMITERS

Limiters available at all channels, buses, headphones, for all sample rates  
Analog first stage, all subsequent stages digital  
Attack time: 1 ms  
Release time: adjustable, 50 ms to 1000 ms  
Threshold: adjustable, -2 dBFS to -12 dBFS  
Selectable ratio: inf:1, 20:1, 18:1, 16:1, 14:1, 12:1, 10:1

## DELAY

Channel Adjustable 0-50 ms  
Output Adjustable 0-500 ms

## MAXIMUM GAIN

Trim stage (mic input): 76 dB  
Trim stage (line input): 50 dB  
Fader stage: 16 dB  
Bus stage: 16 dB  
Headphone stage: 20 dB  
Mic-to-Line: 108 dB  
Mic-to-Headphone: 112 dB  
TA5 (along with mic input pins) for single connection to headset + mic  
High output, 4 ohm output impedance, 400 mW + 400 mW at each connector, all individually driven  
Compatible with headphones of any impedance

## OUTPUTS

XLR (L, R) active-balanced, 250/3.2k/120 ohms (mic/-10/line)  
TA3 (X1/X2) active-balanced, 250/3.2k/120 ohms (mic/-10/line)  
3.5mm (X3/X4): unbalanced, stereo, 1.8k ohms

## HEADPHONE OUTPUTS

¼", 3.5 mm  
TA5 (along with mic input pins) for single connection to headset + mic  
High output, 4 ohm output impedance, 400 mW + 400 mW at each connector, all individually driven  
Compatible with headphones of any impedance

## MAXIMUM OUTPUT LEVEL

(all into 10k load)  
Line: +20 dBu (7.8 Vrms)  
"-10": +6 dBu (1.5 Vrms)  
Mic: -20 dBu (0.078 Vrms)  
X3/X4 Out: +6 dBu (1.5 Vrms)  
Headphone outputs (¼", TA-5): +14 dBu (4.0 Vrms)

## A/D CONVERTERS

32-bit, 120 dB, A-weighted dynamic range typical  
Sampling rates 44.1 kHz, 47.952 kHz, 48 kHz, 48.048 kHz, 88.2 kHz, 96 kHz, 192 kHz

## DIGITAL OUTPUTS

AES3 transformer-balanced, in pairs; 1-2 (XLR-L), 3-4 (XLR-R), 110 ohm, 2 V p-p, AES and S/PDIF compatible

## RECORDING

Internal 256 GB SSD; two removable SD Cards, 10% over-provisioned for optimum performance  
Simultaneous recording to internal SSD and the two SD cards  
exFAT formatting  
12 tracks (8 iso channels, 4 buses)  
Broadcast WAV monophonic and polyphonic file format  
64-bit WAV (RF64) monophonic and polyphonic; support for files > 4 G

## AUTOMATIC MIXING

Dugan Automixing for up to 8 channels on left and right mix bus

## USB

USB-C (USB 3.1 type 1) for file transfer of internal SSD, both SD Cards  
USB-A host for keyboard, external controller, external USB hubs supported for connecting multiple devices

**TIMECODE AND SYNC**

Modes Supported: Off, Rec Run, Free Run, 24h Run, External, including External Auto-Record and Continuous modes.  
Frame Rates: 23.98\*, 24, 25, 29.97 DF, 29.97 ND, 30 DF, 30 ND  
Sample/Timecode Accuracy: 0.1 ppm (0.25 frames per 24 hours)  
Timecode Input: 20k ohm impedance, 0.3 V - 3.0 V p-p (-17 dBu - +3 dBu)  
Timecode Output: 75 ohm impedance, 5 V p-p (+12 dBu)  
Word Clock Input: 10k/75 ohm selectable impedance, 1-5 V p-p input sensitivity  
Word Clock Output: 75 ohm impedance, 5 V p-p output, at SR

**REMOTE CONTROL**

USB MIDI MCU Control - supported 3rd party fader controllers  
SD-Remote Android app  
USB Keyboard  
External Timecode Record Trigger

**LCD**

320x240, Transflective, excellent sunlight visibility  
Larger touchscreen display available via USB-connected SD-Remote app

**POWER**

External: 10-18 V input on locking TA4 connector, pin-4 = (+), pin-1 = (-)  
Dual rear-mount Sony-style L-mount batteries with chargers  
Idle Current Draw: 875 mA @ 12 V (10.5 W)  
Intelligent power-down of unused mic preamps and other internal circuits

**ENVIRONMENTAL**

Operating: -20° C to 60° C, 0 to 90% relative humidity (non-condensing)  
Storage: -40° C to 85° C

**DIMENSIONS (H X W X D)**

5.1 cm x 22 cm x 17 cm;  
(2.0 in. x 8.7 in. x 6. in)

**WEIGHT**

2.75 lbs (unpackaged, without batteries)  
1.25 kg (unpackaged, without batteries)

## FCC &amp; ISED Compliance Statements



This device complies with part 15 of the FCC Rules. Operation is subject to the following two conditions: (1) This device may not cause harmful interference, and (2) this device must accept any interference received, including interference that may cause undesired operation.

Changes or modifications not expressly approved by the manufacturer could void the user's authority to operate the equipment.

This device contains transmitter module FCC ID: XF6-M7DB6  
This device contains transmitter module IC: 8407A-M7DB6

## FCC Interference Statement

This equipment has been tested and found to comply with the limits for a Class B digital device, pursuant to part 15 of the FCC Rules. These limits are designed to provide reasonable protection against harmful interference in a residential installation. This equipment generates, uses and can radiate radio frequency energy and, if not installed and used in accordance with the instructions, may cause harmful interference to radio communications. However, there is no guarantee that interference will not occur in a particular installation. If this equipment does cause harmful interference to radio or television reception, which can be determined by turning the equipment off and on, the user is encouraged to try to correct the interference by one or more of the following measures:

- Reorient or relocate the receiving antenna.
- Increase the separation between the equipment and receiver.
- Connect the equipment into an outlet on a circuit different from that to which the receiver is connected.
- Consult the dealer or an experienced radio/TV technician for help.

## FCC &amp; ISED User Statement

This device complies with FCC and ISED RF exposure limits for general population / uncontrolled environments.

Cet appareil est conforme à la norme FCC et ISED les limites d'exposition pour la population générale / l'exposition incontrôlée.

A separation distance of at least 20cm must be maintained between the antenna and all persons. This device must not be co-located with any other antenna or transmitter.

This device (containing FCC ID: XF6-M7DB6, IC: 8407A-M7DB6) has been approved to operate with the antenna type listed below:

Type: 2.4/5.8 GHz Dipole Antenna  
Gain: 3.8 dBi (2.4 GHz), 5.5dBi (5.8 GHz)

No change to the antenna type is permitted. Any change to the antenna could result in the device exceeding the RF exposure requirements and void the user's authority to operate the device.

This Device complies with Industry Canada License-exempt RSS standard(s). Operation is subject to the following two conditions: 1) this device may not cause interference, and 2) this device must accept any interference, including interference that may cause undesired operation of the device.

Cet appareil est conforme avec Industrie Canada, exempts de licence standard RSS (s). Son fonctionnement est soumis aux deux conditions suivantes: 1) ce dispositif ne peut pas causer d'interférences, et 2) ce dispositif doit accepter toute interférence, y compris les interférences qui peuvent causer un mauvais fonctionnement de l'appareil.

Incorrect use of batteries poses a danger of explosion. Replace only with the same or equivalent type. Properly recycle batteries. Do not crush, disassemble, incinerate, dispose in a fire or expose batteries to high temperatures.

## Declaration of Conformity

Manufacturer's Name: Sound Devices, LLC  
Manufacturer's Address: E7556 State Road 23 and 33  
Reedsburg, WI 53959 USA



**Declares under sole responsibility that the product as delivered**

Product Name: 833  
Model Number: 833  
Description: Mixer-Recorder  
Product Options: This declaration covers all options of the above product.

**complies with the essential requirements of the following applicable European Directives, and carries the CE marking accordingly:**

Radio Equipment Directive (2014/53/EU)  
Article 3.1b:  
ETSI EN 301 489-17 v3.1.1  
EN 55032:2012  
EN 55032:2/AC:2013  
CISPR 32:2012  
EN 55103-2:2009  
Article 3.2:  
ETSI EN 300 328 v2.1.1

This Declaration of Conformity applies to the above-listed product(s) placed on the EU market after:

September 12, 2019

Date

Matt Anderson - Sound Devices, LLC President

# Glossary

## **¼-inch jack**

Common analog audio connector used as both an audio input and output. When a ¼-inch jack is described as TRS (tip-ring-sleeve) it can be wired as either a balanced connection or as a two-channel connection. ¼-inch headphone jacks are typically wired as TRS stereo jacks.

## **3.5 mm jack**

Common small-format audio connector. Often used for headphones and -10 dBV signals for portable audio devices.

## **AES3**

A standard for the exchange of digital audio signals between professional audio devices. An AES3 signal can carry two channels of PCM audio over balanced, 110 ohm interconnections. AES3 is most commonly interconnected with XLR-3 cables.

## **AES42**

A digital interface protocol for microphones and microphone inputs. Microphones conforming to this standard directly output digital audio through an XLR or XLD male connector, rather than producing an analog output. AES42 microphones require powering.

## **Attenuation**

A reduction in the level of an audio signal. Attenuation can be applied to both analog and digital signals. A fader is used primarily to attenuate signals, though a small amount of positive gain is often available on a fader.

## **Bext chunk**

Broadcast WAV extension data added to the audio data in a WAV file. The bext chunk includes timecode and user bit data. For systems that do not recognize the bext chunk this additional information is ignored.

## **Bit depth**

When converting between analog and PCM digital audio the amplitude of an analog signal is measured in finite steps, measured in bits. Higher bit rates result in greater resolution of amplitudes, resulting in higher dynamic range. 24-bit audio, with a theoretical maximum dynamic range of 144 dB, is the standard bit depth used throughout the audio chain for production.

## **Broadcast WAV, BWA**

Broadcast WAV files are WAV files with additional, non-audio data, such as bEXT chunk data. Broadcast WAV files offer timecode support.

## **Bus**

An audio path that is the destination of one or multiple (mixed) channels. A bus is typically routed to an output, a record track, or both.

## **Camera return**

An audio input on a mixer designed to receive the output, typically the headphone output, of a camera. Camera return inputs allow the user to monitor the level and quality of the signal received at the camera. On the 833 the Aux In can be used as a source for any channel.

## **Channel**

A "slot" of a mixer that is controllable and routable. A given input feeds the channel and the channel's settings process and route the audio as required. It can also be thought of as the path its selected input signal takes on its way to its record track, a bus, or an output.

## **Channel grouping**

With the 833 all of the 8 channels can be grouped together so that their faders, record arming state mute states can be controlled together. Channel grouping can be used as an alternative to sending channels to a bus.

## **Circled take**

An identifying character, the @ symbol, which is placed in the file name to highlight a take. Circled takes can either be used to identify good takes or to identify tracks or takes that will be ignored.

## **Com return**

A dedicated audio input designed to receive signals from a PL, or private line communications circuit. The com return on the 833 can be routed to an output or a bus.

## **Com send**

A dedicated output designed to send signal to a PL (private line, talkback) communications circuit. The com send is toggled by a front panel switch.

## **dBFS**

A measurement of the signal level of a digital signal in dB increments, dB relative to full scale signal. The maximum signal in dBFS is 0 dBFS, with signals expressed with a negative sign. dBFS signal strength is an internal measurement and does not correspond to analog signals unless the relationship between analog signal and digital signal is known.

## **Delay (channel)**

Time delay that can be applied to an individual channel. Channel delay, typically set in milliseconds, is often used to compensate for different acoustical or electrical arrival times of signals between channels.

## **exFAT**

A storage volume format that can be read and written from current versions of MacOS and Windows. exFat supports volume sizes up to 128 PB (gigantic), and individual files can have a maximum size of 16 EB (even more gigantic, bigger than the maximum volume size).

## **Fader**

A physical control on a mixing console, either a rotary or sliding potentiometer, that controls the level of a channel to a bus. Most faders have more attenuation than gain available and a unity gain position where the input trim level established the level to the bus.

## **False take**

A recorded take that was either erroneously recorded, or a take that needs to be repeated. It can be labeled after recording. An identified false take is moved to the trash bin and the auto-incrementing take number is reset to the value prior to the false take.

## **File list**

Every file recorded by a recorder is visible in the file list. It can be viewed either on a recorder or from a computer when the recording volume is mounted. The file list shows all the individual files recorded by a recorder.

**Frame rate**

The rate at which video or motion picture images are recorded or played back, measured in frames-per second (FPS). All audio and video devices must be running at the same frame rate to keep audio and video synchronized. Timecode frame rates are either an integer or non-integer value. Integer values include 24, 25, and 30 FPS. Non-integer frame rates include 23.976 and 29.97, and 29.97 drop FPS.

**Frequency**

The period at which a wave oscillates, measured in hertz (Hz). Frequencies audible to humans range from 20 Hz for very low frequency signals to 20 kHz for very high frequency signals.

**Gain**

An increase (or decrease with negative gain) in the level of an audio signal. Gain can be applied in several locations, to both analog and digital signals. In a field mixer the microphone preamplifier provides a substantial amount of gain at the trim to raise the low level microphone signal to a usable signal in the mixer. Gain is also available at the fader. Gain of digital signals or line level analog signals is often limited. Unity gain is gain stage that neither adds or subtracts level from a signal.

**Headphone monitor**

Often a separate bus with a dedicated headphone volume control, the headphone monitor typically is normalled to the main left/right output bus of a mixer. Headphone sources can often be selected among soloed tracks or buses. In some products complex headphone monitoring of MS Stereo, LR stereo, and ambisonic sources is available.

**High pass filter (audio)**

Also referred to as a low-cut filter, this circuit reduces the amount of low frequency content in an audio signal. A HPF is particularly useful when recording speech since the human voice does not generate appreciable energy at low frequencies. The HPF reduces non-speech signals such as environmental noise, wind noise, and microphone handling noise, improving the intelligibility of speech and reducing low frequencies from overloading the input. The high pass filter is placed in the circuit close to the microphone preamplifier.

High pass filters are often frequency selectable, ranging from 20 Hz to 200 Hz. HPF also have a slope, generally from 3 dB/octave to 18 dB/octave. Greater/steeper slopes offer more attenuation of frequencies just below the set filter frequency.

**Input**

The physical connection and associated signal type from external sources connected to a device. Inputs can include microphone inputs on XLR connectors or USB audio inputs from a computer. Depending on the architecture of the mixing console its inputs may be hardwired to channels or channels can be selected from different inputs.

**Input limiter**

A limiter circuit reduces the peak signal levels of audio, generally to prevent signal overload. Analog inputs have a maximum input signal level that can be reached before overload/distortion is introduced. Setting the input gain correctly so that input signals do not reach this maximum level prevents most overload conditions. In the presence of very high, unexpected signals an input limiter changes the gain of the incoming signal and prevents it from overloading. Input limiters are sometimes compressor-type circuits with a ratio of infinity:1, meaning that any increase to the input signal into the limiter at the limiter threshold does not increase the output signal of the limiter.

Several parameters may be available in a limiter, including knee, ratio, release, and threshold.

**Isolated track**

A recorded track of an individual microphone or sound source. “Iso” recordings allow for post-record mixing of individual sound elements.

**iXML**

An extensible data schema for audio and related metadata stored in broadcast WAV files. Manufacturer-specific data generated during recording is stored in iXML.

**Line level**

An analog audio signal used to interconnect audio equipment. Line level may be balanced or unbalanced, referenced to +4 dBu or -10 dBV, professional or consumer respectively.

**Low cut filter**

See high pass filter.

**Microphone level**

The audio signal generated by a microphone. Mic level signals are very low level, requiring a microphone preamplifier to bring them to usable, line levels. Interconnects with microphone level signals can be subject to noise and interference.

**Mid-side linking (inputs)**

When mid-side (MS) stereo inputs are used and the inputs are set to MS linking and MS decoder is activated for those inputs. This yields a stereo signal with one fader controlling overall input level and the other fader controlling the “width”, or amount of the side signal added. With an MS matrix at the input, the signal is sent to an output bus as left/right stereo. Mixers with MS matrices often allow for discrete mid and side signal recording. In that case the MS decoder can be activated at the headphone selection to monitor left/right stereo.

**Mix track**

A recorded track that is a sum of multiple tracks. In production sound the mix track is often a single summed track of all production dialog elements. Mix tracks can also be sub-mixes of like microphones, such as a sub mix of just lavalier microphones or just boom microphones.

**Monophonic WAV**

A WAV file that is comprised of a single track of audio. When recording multi-track audio with monophonic WAV files each track is recorded to its own WAV file, with a file name indicating the track number. All associated monophonic files that are part of a multi-track recording will be identical lengths.

**Mute**

A mute control is a convenient on/off switch for a channel and an easy way to remove a channel from appearing in downstream buses. Mute an input or channel does not change levels or settings; when channels are muted and unmuted, their settings remain.

**Notes (metadata)**

A metadata field that is saved along with audio data in a recorded sound file, useful for sound report generation. Some workstation software recognizes the notes field and presents it when viewing the sound file.

**Output**

The physical connection and associated signal type sent from a device. Outputs can be source from inputs, buses, record tracks, and other auxiliary signals.

**Output auto-mute**

When set, an output signal is muted when recording is stopped, restricting program audio from being sent to listeners “between takes”.

**Output delay**

A digital delay applied at the output. Signal delay is often set at an output to compensate for the delay introduced by digital imaging systems so that picture and sound remain in correct “lip sync”. Output delay is set in either frames or milliseconds.

**Pan**

When a channel is routed to a stereo-linked bus the level it appears at each bus is adjusted by a pan control. A channel with its pan control “straight up the center”, or “centered” sends signal at the same level to each bus. A channel that is panned left or right sends the signal to the left or right bus, respectively.

**PFL, pre-fade listen**

When an input or channel is selected for monitoring/solo with a PFL, the channel is routed to the headphone output before the channel fader so that the fader position has no effect on the headphone level. Trim/gain changes to the input will change the headphone output.

**Phantom power**

Condenser (capacitor) microphones require power for operation. They use power to charge the diaphragm backplate (for true condensers) and power the impedance convert located adjacent to the microphone capsule. Phantom power is the method for microphone inputs to supply DC power to the microphone through the same connection used for the audio signals from the microphone.

Phantom power provides a positive voltage, typically between 11-52 VDC, with 48 V being the most common, on both pin-2 and pin-3 with pin-1 used as ground. The DC voltage appears as a common-mode signal on the balanced connection and is rejected by the connection’s differential amplifier. Phantom power has no effect on dynamic microphones.

**Phase**

The relationship one audio signal has in time with respect to another audio signal, defined in degrees of phase. When audio signals are generated at identical times, they are “in phase” with each other. When one audio signal is time-delayed with respect to another the signals are “out of phase”. Differing phase relationships can be introduced several ways, including when microphones are placed at varying distances from a sound source, or electrical/digital delay is introduced to one signal with respect to another.

**Phrase**

A pre-set text string which can be used to quickly fill out the notes field.

**Pre-fader routing**

The signal from a channel is routed to a bus before the fader in the signal path. The input trim, if available, controls the channel level sent to the bus. Isolated tracks are typically recorded pre-fader so that any level changes made to the faders don’t affect the recorded signal.

**Pre-roll**

A continuous buffer that is always writing to memory offering a recording that begins prior to when the record button is activated. Pre-roll is set in seconds, and the recording begins the set number of seconds prior to the button being pressed. This is helpful in applications where an operator missed a cue to begin recording.

**Polarity (audio)**

The direction of the current flow of an audio signal is defined as polarity. The polarity of a signal can reversed when a balanced audio signal connection has its pin-2 and pin-3 connections reversed. Single-ended signals can have their polarity reversed when going through an “inverting” gain stage. It is best practice to have all incoming and outgoing signals with the same polarity relationship.

**Polyphonic WAV**

An individual WAV file that contains multiple audio tracks. When recording multi-track audio with polyphonic WAV files all recorded tracks are contained within a single WAV file.

**Post-fader routing (after fade routing, AFL)**

The signal from a channel is routed to a bus after the fader in the signal path. The fader controls the level of the channel at the bus. Channels sent to a master bus, such as the left/right bus, are typically sent post-fader.

**Post-roll**

An extra period of time that is appended to the end of a recording when stop is pressed. If record is pressed during this period of time, recording will resume within the same file with no audio lost. This is particularly useful should a Director call ‘cut’ prematurely or accidentally.

**Project**

An option available for file organization on Sound Devices recorders. Projects are the highest level of file folder organization. The project folder can contain sub-folders of scene files or recorded files directly.

**Record bell**

A tone generated in headphones to alert the listener that recording has started. The bell is also produced when recording has ended with the stop button, when the recording volume is full, or when power is in a critical state.

**Sampling rate**

When converting between analog and PCM digital audio the analog signal is measured (sampled) in unique steps at a data rate specified in kHz. Higher sampling rates allow for representing higher frequency analog audio. 48 kHz is the standard sampling rate for production, worldwide. Higher sampling rates including 96 kHz and 192 kHz are used for high-precision applications where the representation of audio above 20 kHz is required. A general rule is that the maximum analog audio frequency is  $\frac{1}{2}$  the sampling rate.

**Scene**

On Sound Devices recorders the scene becomes part of the file name for a take. Scene names can be pre-loaded to quickly change between scenes.

**Slate microphone**

A microphone, built-in or external microphone, on an audio mixer used to notate takes or communicate with sound team members by the mixer’s user speaking into the microphone. Slate microphones are often routable to buses or tracks.

**Stereo linking (inputs)**

When active for stereo sources such as stereo microphones, linked inputs are hard panned to the left and right bus. Controls including gain (trim), fader, high pass filter, delay, limiter, mute, and routing are controlled together.

**Solo**

A control on a mixer to route a channel to headphones while muting all others. Solo and PFL are related controls and in many consoles are the same. Solo circuits can be exclusive—only one channel is sent to headphones at a time—or non-exclusive—any number of channels can be sent to the solo circuit and appear in headphones.

**TA-type connector (TA3, TA4, TA5)**

Miniature XLR-type, locking connectors. TA3 connectors are used by Sound Devices for various inputs, outputs, and as balanced and unbalanced connections. TA4 connectors are used by Sound Devices for DC power connections to the 833 mixer-recorder. TA4 is also used for audio connections from lavalier microphones to some wireless transmitters. TA5 connectors are used for the 833 headset input. TA6 connectors are presently not used by Sound Devices though they are used for audio connections by other manufacturers.

**Take**

A recorded take is an individual recorded file (or files when recording monophonic WAV files) generated by a recorder. Take numbers are auto-incrementing. Take numbers are added to the end of the file name.

**Take list**

Separate from a file list, a take list consolidates related files such as a group of monophonic WAV files generated by a single take and presents them as a single take.

**Test tone**

See tone oscillator.

**Timecode**

A numerical clock value expressed in hours:minutes:seconds:frames, i.e. 04:59:39:05, used to synchronize cameras, video decks, and audio recorders. Timecode requires clocks on devices to be synchronized, either through a wired or wireless connection between devices, or through a process called “jam sync” where each device, which requires a high-precision clock, runs independently after their clocks are synchronized.

**Timecode mode**

Sound Devices recorders offer multiple timecode modes. Different modes correspond to different timecode workflows. Common modes available in Sound Devices recorders include:

- record run - timecode advances only when recording is engaged
- free run - timecode run continuously, typically with the start of production being at 0 hour
- 24 hour - similar to free run except the start time corresponds to time-of-day
- ext TC - the recorder applies the value of an external timecode source.

**Tone oscillator**

A sound generator producing a sine wave tone at a given frequency at a given output level. With its known output level tone oscillators are helpful to set gain structure between audio equipment.

**Track**

A single recorded audio signal. Common recorded tracks are the main left/right master audio bus and isolated (iso) channel recordings. Iso tracks are typically identified by the channel of the same number, e.g. channel 1 is sent to track 1, channel 2 is sent to track 2, etc.

**Track arm**

Tracks that are active and ready for recording are said to be “armed”. When recording begins all armed tracks begin recording. Depending on the production it may be advantageous to arm and disarm tracks, especially to disarm unused tracks.



This product incorporates software subject to the BSD license:

Copyright 2001-2010 Georges Menie ([www.menie.org](http://www.menie.org))

All rights reserved. Redistribution and use in source and binary forms, with or without modification, are permitted provided that the following conditions are met

\* Redistributions of source code must retain the above copyright notice, this list of conditions and the following disclaimer.

\* Redistributions in binary form must reproduce the above copyright notice, this list of conditions and the following disclaimer in the documentation and/or other materials provided with the distribution.

\* Neither the name of the University of California, Berkeley nor the names of its contributors may be used to endorse or promote products derived from this software without specific prior written permission.

\* THIS SOFTWARE IS PROVIDED BY THE REGENTS AND CONTRIBUTORS ``AS IS'' AND ANY EXPRESS OR IMPLIED WARRANTIES, INCLUDING, BUT NOT LIMITED TO, THE IMPLIED WARRANTIES OF MERCHANTABILITY AND FITNESS FOR A PARTICULAR PURPOSE ARE DISCLAIMED. IN NO EVENT SHALL THE REGENTS AND CONTRIBUTORS BE LIABLE FOR ANY DIRECT, INDIRECT, INCIDENTAL, SPECIAL, EXEMPLARY, OR CONSEQUENTIAL DAMAGES (INCLUDING, BUT NOT LIMITED TO, PROCUREMENT OF SUBSTITUTE GOODS OR SERVICES; LOSS OF USE, DATA, OR PROFITS; OR BUSINESS INTERRUPTION) HOWEVER CAUSED AND ON ANY THEORY OF LIABILITY, WHETHER IN CONTRACT, STRICT LIABILITY, OR TORT (INCLUDING NEGLIGENCE OR OTHERWISE) ARISING IN ANY WAY OUT OF THE USE OF THIS SOFTWARE, EVEN IF ADVISED OF THE POSSIBILITY OF SUCH DAMAGE.

Two Level Segregated Fit memory allocator, version 3.1.

Written by Matthew Conte

[Http://tlsf.baisoku.org](http://tlsf.baisoku.org)

Based on the original documentation by Miguel Masmano:

<http://www.gii.upv.es/tlsf/main/docs>

This implementation was written to the specification of the document, therefore no GPL restrictions apply.

Copyright (c) 2006-2016, Matthew Conte All rights reserved.

Redistribution and use in source and binary forms, with or without modification, are permitted provided that the following conditions are met:

\* Redistributions of source code must retain the above copyright notice, this list of conditions and the following disclaimer.

\* Redistributions in binary form must reproduce the above copyright notice, this list of conditions and the following disclaimer in the documentation and/or other materials provided with the distribution.

\* Neither the name of the copyright holder nor the names of its contributors may be used to endorse or promote products derived from this software without specific prior written permission.

\*\* THIS SOFTWARE IS PROVIDED BY THE COPYRIGHT HOLDERS AND CONTRIBUTORS "AS IS" AND ANY EXPRESS OR IMPLIED WARRANTIES, INCLUDING, BUT NOT LIMITED TO, THE IMPLIED WARRANTIES OF MERCHANTABILITY AND FITNESS FOR A PARTICULAR PURPOSE ARE DISCLAIMED. IN NO EVENT SHALL MATTHEW CONTE BE LIABLE FOR ANY DIRECT, INDIRECT, INCIDENTAL, SPECIAL, EXEMPLARY, OR CONSEQUENTIAL DAMAGE (INCLUDING, BUT NOT LIMITED TO, PROCUREMENT OF SUBSTITUTE GOODS OR SERVICES; LOSS OF USE, DATA, OR PROFITS; OR BUSINESS INTERRUPTION) HOWEVER CAUSED AND ON ANY THEORY OF LIABILITY, WHETHER IN CONTRACT, STRICT LIABILITY, OR TORT (INCLUDING NEGLIGENCE OR OTHERWISE) ARISING IN ANY WAY OUT OF THE USE OF THIS SOFTWARE, EVEN IF ADVISED OF THE POSSIBILITY OF SUCH DAMAGE.

**SOUND**  **DEVICES**

Post Office Box 576  
E7556 State Rd. 23 and 33  
Reedsburg, Wisconsin 53959 USA

**[support@sounddevices.com](mailto:support@sounddevices.com)**

+1 608.524.0625 main  
800.505.0625 toll free

**[www.sounddevices.com](http://www.sounddevices.com)**